

## GENERAL INSTRUMENTS

### KNIVES

Dissecting, Autopsy, Cartilage, Post Mortem, Brain, Amputation, Interosseous and Resection Knives

**Oltten**  
Instruments



#### All Metal SHAPE 1

REF #	SIZE cm	SIZE in	BLADE
AO-0001	15.0 cm	6"	27 mm
AO-0002	15.0 cm	6"	35 mm
AO-0003	16.0 cm	6¼"	40 mm
AO-0004	16.0 cm	6¾"	47 mm
AO-0005	17.0 cm	6¾"	50 mm
AO-0006	11.5 cm	4½"	30 mm



#### Wooden Handle SHAPE 1

REF #	SIZE cm	SIZE in	BLADE
AO-0013	15.0 cm	6"	27 mm
AO-0014	15.0 cm	6"	35 mm
AO-0015	16.0 cm	6¼"	40 mm
AO-0016	16.0 cm	6¾"	47 mm
AO-0017	17.0 cm	6¾"	50 mm



REF #	SIZE cm	SIZE in	BLADE
AO-0023	25.5 cm	10"	100 mm

Standard  
Dissecting Knife

Standard  
Autopsy Knife  
(wooden handle)



REF #	SIZE cm	SIZE in	BLADE
AO-0024	21.0 cm	8¼"	80 mm



REF #	SIZE cm	SIZE in	BLADE
AO-0025	26.0 cm	10¼"	110 mm
AO-0026	29.0 cm	11½"	140 mm
AO-0027	31.0 cm	12¼"	170 mm



REF #	SIZE cm	SIZE in	BLADE
AO-0028	28.5 cm	11¼"	160 mm
AO-0029	33.5 cm	13¾"	200 mm
AO-0030	38.0 cm	15"	240 mm

Standard  
Cartilage Knife  
(wooden handle)

Walb  
Post Mortem Knife  
(wooden handle)

Virchow  
Brain Knife  
(hollow handle)



REF #	SIZE cm	SIZE in	BLADE
AO-0031	29.0 cm	11½"	160 mm
AO-0032	32.5 cm	12¾"	190 mm



REF #	SIZE cm	SIZE in	BLADE
AO-0033	29.0 cm	11½"	160 mm



REF #	SIZE cm	SIZE in	BLADE
AO-0034	18.0 cm	7"	65 mm

Standard  
Amputation Knife  
(hollow handle)

Catlin  
Interosseous Knife  
(hollow handle)

Standard  
Resection Knife  
(solid handle)



## GENERAL INSTRUMENTS

Knives-Razors-Blade Breakers  
Resection Knives, Blade Breakers, Razor Knives

**Oiten**  
Instruments



REF # SIZE cm SIZE in BLADE  
AO-0035 18.0 cm 7" 55 mm

Langenbeck  
Resection Knife



REF # SIZE cm SIZE in BLADE  
AO-0036 18.0 cm 7" 55 mm

Langenbeck  
Resection Knife



REF # SIZE cm SIZE in  
AO-0037 31.0 cm 12 1/4"

Humby  
Skin Graft Knife  
Without Blade



REF # BLADE  
AO-0038 75 mm x 16mm

Standard  
Razor Knife



REF # BLADE  
AO-0039 80 mm x 22mm

Standard  
Razor Knife



REF #  
AO-0040

Standard  
Razor For Interchangeable Blades  
With Safety Clip



REF # SIZE cm SIZE in BLADE  
AO-0041 09.0 cm 3 1/2" 5.5 mm

Troutman-Chris  
Blade Holder / Blade Breaker



REF # SIZE cm SIZE in BLADE  
AO-0042 09.0 cm 3 1/2" 5.5 mm

Standard  
Blade Holder / Blade Breaker



REF # SIZE cm SIZE in BLADE  
AO-0043 11.0 cm 4 1/4" 6.0 mm

Standard  
Blade Holder / Blade Breaker

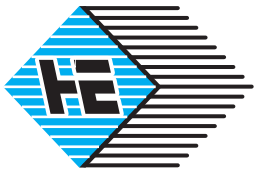

## GENERAL INSTRUMENTS

Blade Breakers - Scalpels  
Scalpel Handles



REF # SIZE cm SIZE in BLADE  
AO-0044 13.0 cm 5" 8.0 mm

Castroviejo  
Blade Holder / Blade Breaker



REF # SIZE cm SIZE in  
AO-0045 13.5 cm 5¼"

Standard  
Scalpel Handle



REF # SIZE cm SIZE in  
AO-0046 9.5 cm 3¾"

Miniature  
Blade Handle  
W/Self-Locking Chuck



REF # SIZE cm SIZE in SHAPE  
AO-0047 12.5 cm 5" No.3

Standard  
Scalpel Handle



REF # SIZE cm SIZE in SHAPE  
AO-0048 12.5 cm 5" No.3

Standard  
Scalpel Handle



REF # SIZE cm SIZE in SHAPE  
AO-0049 21.0 cm 8¼" No.3L

Standard  
Scalpel Handle



REF # SIZE cm SIZE in SHAPE  
AO-0050 21.0 cm 8¼" No.3L

Standard  
Scalpel Handle



REF # SIZE cm SIZE in SHAPE  
AO-0051 16.0 cm 6¼" No.4 + No.3

Standard  
Scalpel Handle



REF # SIZE cm SIZE in SHAPE  
AO-0052 12.0 cm 4¾" No.3

Standard  
Scalpel Handle

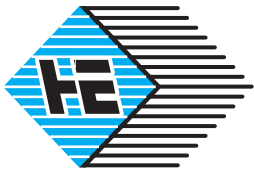

## GENERAL INSTRUMENTS

Scalpels  
Scalpel Handles



REF # SIZE cm SIZE in SHAPE  
AO-0053 15.5 cm 6" No.3

Standard Scalpel Handle



REF # SIZE cm SIZE in SHAPE  
AO-0054 14.5 cm 5 3/4" No.3

Standard Scalpel Handle



REF # SIZE cm SIZE in SHAPE  
AO-0055 14.0 cm 5 1/2" No.3

Standard Scalpel Handle



REF # SIZE cm SIZE in SHAPE  
AO-0056 15.0 cm 6" No.3

Kaye Scalpel Handle



REF # SIZE cm SIZE in SHAPE  
AO-0057 12.5 cm 5" No.3

Standard Scalpel Handle (Plastic Handle)



REF # SIZE cm SIZE in SHAPE  
AO-0058 13.5 cm 5 1/4" No.4

Standard Scalpel Handle



REF # SIZE cm SIZE in SHAPE  
AO-0059 21.0 cm 8 1/4" No.4

Standard Scalpel Handle



REF # SIZE cm SIZE in SHAPE  
AO-0060 21.0 cm 8 1/4" No.4L

Standard Scalpel Handle



REF # SIZE cm SIZE in SHAPE  
AO-0061 21.0 cm 8 1/4" No.4L

Standard Scalpel Handle

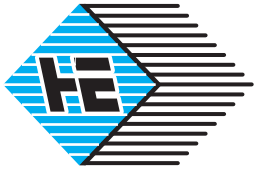

## GENERAL INSTRUMENTS

### SCISSORS

Operating Scissors, Incision Scissors, Dissecting Scissors



REF #	SIZE cm	SIZE in	SHAPE
BO-0120	12.0 cm	4½"	str
BO-0121	13.0 cm	5"	str
BO-0122	14.5 cm	5½"	str
BO-0123	15.5 cm	6"	str
BO-0124	16.5 cm	6½"	str
BO-0125	18.5 cm	7¼"	str
BO-0126	20.5 cm	8"	str
BO-0127	23.0 cm	9"	str
BO-0128	25.5 cm	10"	str
BO-0129	12.0 cm	4½"	cvd
BO-0130	13.0 cm	5"	cvd
BO-0131	14.5 cm	5½"	cvd
BO-0132	15.5 cm	6"	cvd
BO-0133	16.5 cm	6½"	cvd
BO-0134	18.5 cm	7¼"	cvd
BO-0135	20.5 cm	8"	cvd
BO-0136	23.0 cm	9"	cvd
BO-0137	25.5 cm	10"	cvd

**Standard**  
Operating Scissors  
Blunt / Blunt



REF #	SIZE cm	SIZE in	SHAPE
BO-0138	12.0 cm	4½"	str
BO-0139	13.0 cm	5"	str
BO-0140	14.5 cm	5½"	str
BO-0141	15.5 cm	6"	str
BO-0142	16.5 cm	6½"	str
BO-0143	18.5 cm	7¼"	str
BO-0144	20.5 cm	8"	str
BO-0145	23.0 cm	9"	str
BO-0146	25.5 cm	10"	str
BO-0147	12.0 cm	4½"	cvd
BO-0148	13.0 cm	5"	cvd
BO-0149	14.5 cm	5½"	cvd
BO-0150	15.5 cm	6"	cvd
BO-0151	16.5 cm	6½"	cvd
BO-0152	18.5 cm	7¼"	cvd
BO-0153	20.5 cm	8"	cvd
BO-0154	23.0 cm	9"	cvd
BO-0155	25.5 cm	10"	cvd

**Standard**  
Operating Scissors  
Blunt / Sharp



REF #	SIZE cm	SIZE in	SHAPE
BO-0156	12.0 cm	4½"	str
BO-0157	13.0 cm	5"	str
BO-0158	14.5 cm	5½"	str
BO-0159	15.5 cm	6"	str
BO-0160	16.5 cm	6½"	str
BO-0161	18.5 cm	7¼"	str
BO-0162	20.5 cm	8"	str
BO-0163	23.0 cm	9"	str
BO-0164	25.5 cm	10"	str
BO-0165	12.0 cm	4½"	cvd
BO-0166	13.0 cm	5"	cvd
BO-0167	14.5 cm	5½"	cvd
BO-0168	15.5 cm	6"	cvd
BO-0169	16.5 cm	6½"	cvd
BO-0170	18.5 cm	7¼"	cvd
BO-0171	20.5 cm	8"	cvd
BO-0172	23.0 cm	9"	cvd
BO-0173	25.5 cm	10"	cvd

**Standard**  
Operating Scissors  
Sharp / Sharp



REF #	SIZE cm	SIZE in	SHAPE
BO-0174	14.0 cm	5½"	blt-bl
BO-0175	14.0 cm	5½"	srp-bl
BO-0176	14.0 cm	5½"	srp-srp

**Grazil**  
Operating Scissors  
Straight / Delicate



REF #	SIZE cm	SIZE in	SHAPE
BO-0177	14.0 cm	5½"	blt-bl
BO-0178	14.0 cm	5½"	srp-bl
BO-0179	14.0 cm	5½"	srp-srp

**Grazil**  
Operating Scissors  
Curved / Delicate



REF #	SIZE cm	SIZE in	SHAPE
BO-0180	14.0 cm	5½"	str

**Standard**  
Operating Scissors



REF #	SIZE cm	SIZE in	SHAPE
BO-0181	14.0 cm	5½"	str
BO-0182	14.0 cm	5½"	cvd

**Deaver**  
Operating Scissors



REF #	SIZE cm	SIZE in	SHAPE
BO-0183	14.5 cm	5½"	str
BO-0184	15.0 cm	6"	str
BO-0185	17.0 cm	6¾"	str
BO-0186	20.0 cm	8"	str
BO-0187	23.5 cm	9"	str
BO-0188	14.5 cm	5½"	cvd
BO-0189	15.0 cm	6"	cvd
BO-0190	17.0 cm	6¾"	cvd
BO-0191	20.0 cm	8"	cvd
BO-0192	23.5 cm	9"	cvd

**Mayo**  
Dissecting Scissors



REF #	SIZE cm	SIZE in	SHAPE
BO-0193	23.0 cm	9"	str
BO-0194	28.0 cm	11"	str
BO-0195	30.0 cm	12"	str
BO-0196	22.5 cm	9"	cvd
BO-0197	28.0 cm	11"	cvd
BO-0198	30.0 cm	12"	cvd

**Mayo-Harrington**  
Dissecting Scissors

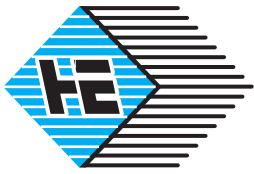

## GENERAL INSTRUMENTS

### SCISSORS

Dissecting Scissors, Gynecological Scissors, Operating Scissors



REF #	SIZE cm	SIZE in	SHAPE
BO-0199	15.0 cm	6"	str
BO-0200	17.0 cm	6¾"	str
BO-0201	15.0 cm	6"	cvd
BO-0202	17.0 cm	6¾"	cvd

Mayo-Stille  
Dissecting Scissors



REF #	SIZE cm	SIZE in	SHAPE
BO-0203	16.0 cm	6¼"	str
BO-0204	19.5 cm	7¾"	str
BO-0205	21.5 cm	8½"	str
BO-0206	16.0 cm	6¼"	cvd
BO-0207	19.5 cm	7¾"	cvd
BO-0208	21.5 cm	8½"	cvd

Mayo-Stille  
Dissecting Scissors



REF #	SIZE cm	SIZE in	SHAPE
BO-0209	16.5 cm	6½"	str
BO-0210	17.5 cm	6¾"	cvd

Mayo-Noble  
Gynecological Scissors



REF #	SIZE cm	SIZE in	SHAPE
BO-0211	20.0 cm	8"	str
BO-0212	23.0 cm	9"	str
BO-0213	20.0 cm	8"	cvd
BO-0214	23.0 cm	9"	cvd

Sims  
Gynecological Scissors



REF #	SIZE cm	SIZE in	SHAPE
BO-0215	16.0 cm	6¼"	str
BO-0216	16.0 cm	6¼"	cvd

Kelly  
Operating Scissors



REF #	SIZE cm	SIZE in	SHAPE
BO-0217	18.5 cm	7¼"	str
BO-0218	18.5 cm	7¼"	cvd

Doyen  
Gynecological Scissors



REF #	SIZE cm	SIZE in	SHAPE
BO-0219	24.5 cm	9¾"	str

Sims-Siebold  
Gynecological Scissors



REF #	SIZE cm	SIZE in	SHAPE
BO-0220	24.5 cm	9¾"	cvd

Sims-Siebold  
Gynecological Scissors



REF #	SIZE cm	SIZE in	SHAPE
BO-0221	20.0 cm	8"	cvd
BO-0222	23.0 cm	9"	cvd

Wertheim  
Gynecological Scissors



## GENERAL INSTRUMENTS

### SCISSORS

Dissecting Scissors, Nerve Dissecting Scissors, Face-Lift Scissors



REF #	SIZE cm	SIZE in	SHAPE
BO-0223	11.5 cm	4½"	str blt-blt
BO-0224	11.5 cm	4½"	cvd blt-blt

Metzenbaum  
Dissecting Scissors



REF #	SIZE cm	SIZE in	SHAPE
BO-0225	14.5 cm	5¾"	str blt-blt
BO-0226	14.5 cm	5¾"	str srp-blt
BO-0227	14.5 cm	5¾"	str srp-srp

Metzenbaum  
Dissecting Scissors



REF #	SIZE cm	SIZE in	SHAPE
BO-0231	15.5 cm	6"	str blt-blt
BO-0232	15.5 cm	6"	cvd blt-blt

Metzenbaum  
Dissecting Scissors



REF #	SIZE cm	SIZE in	SHAPE
BO-0233	18.0 cm	7"	str blt-blt
BO-0234	20.5 cm	8"	str blt-blt
BO-0235	23.0 cm	9"	str blt-blt
BO-0236	26.0 cm	10¼"	str blt-blt
BO-0237	28.5 cm	11¼"	str blt-blt
BO-0238	31.0 cm	12¼"	str blt-blt

Metzenbaum-Nelson  
Dissecting Scissors



REF #	SIZE cm	SIZE in	SHAPE
BO-0239	18.0 cm	7"	str srp-srp
BO-0240	20.5 cm	8"	str srp-srp

Metzenbaum-Nelson  
Dissecting Scissors



REF #	SIZE cm	SIZE in	SHAPE
BO-0241	18.0 cm	7"	cvd blt-blt
BO-0242	20.5 cm	8"	cvd blt-blt
BO-0243	23.0 cm	9"	cvd blt-blt
BO-0244	26.0 cm	10¼"	cvd blt-blt
BO-0245	28.5 cm	11¼"	cvd blt-blt
BO-0246	31.0 cm	12¼"	cvd blt-blt

Metzenbaum-Nelson  
Dissecting Scissors



REF #	SIZE cm	SIZE in	SHAPE
BO-0247	14.5 cm	5¾"	str srp-srp
BO-0248	14.5 cm	5¾"	cvd srp-srp

Metzenbaum  
Dissecting Scissors (toothed)



REF #	SIZE cm	SIZE in	SHAPE
BO-0249	15.5 cm	6"	str srp-srp
BO-0250	15.5 cm	6"	cvd srp-srp

Standard  
Nerve Dissecting Scissors



REF #	SIZE cm	SIZE in	SHAPE
BO-0251	18.5 cm	7¼"	cvd

Kaye  
Face-lift Scissors (toothed)

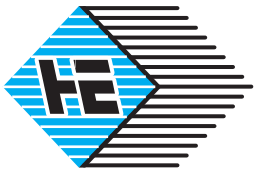

## GENERAL INSTRUMENTS

### SCISSORS

Dissecting Scissors, Face-Lift Scissors, Nasal Scissors,  
Delicate Dissecting Scissors

**Olten**  
Instruments



REF #	SIZE cm	SIZE in	SHAPE
BO-0252	12.5 cm	5"	str
BO-0253	19.5 cm	7¾"	str
BO-0254	19.5 cm	7¾"	cvd

**Gorney**  
Face-lift Scissors (toothed)



REF #	SIZE cm	SIZE in	SHAPE
BO-0255	17.0 cm	6¾"	str

**Aston**  
Face-lift Scissors (toothed)



REF #	SIZE cm	SIZE in	SHAPE
BO-0256	16.0 cm	6¼"	str
BO-0257	16.0 cm	6¼"	cvd

**Lexer**  
Dissecting Scissors



REF #	SIZE cm	SIZE in	SHAPE
BO-0258	11.5 cm	4½"	cvd
BO-0259	14.0 cm	5½"	cvd

**Cinelli**  
Nasal Scissors



REF #	SIZE cm	SIZE in	SHAPE
BO-0260	18.5 cm	7¼"	cvd

**Thorek**  
Dissecting Scissors



REF #	SIZE cm	SIZE in	SHAPE
BO-0261	10.0 cm	4"	str
BO-0262	10.0 cm	4"	cvd

**Lexer-Baby**  
Dissecting Scissors



REF #	SIZE cm	SIZE in	SHAPE
BO-0263	16.5 cm	6½"	str
BO-0264	16.5 cm	6½"	cvd

**Lexer-Fino**  
Delicate Dissecting Scissors  
slender pattern



REF #	SIZE cm	SIZE in	SHAPE
BO-0265	14.5 cm	5¾"	str

**Metzenbaum-Fino**  
Delicate Dissecting Scissors  
slender pattern



REF #	SIZE cm	SIZE in	SHAPE
BO-0266	14.5 cm	5¾"	cvd blt-bit

**Metzenbaum-Fino**  
Delicate Dissecting Scissors  
slender pattern



## GENERAL INSTRUMENTS

### SCISSORS

Delicate Dissecting Scissors, Operating Scissors,  
Dissecting Scissors, Face-Lift Scissors



REF #	SIZE cm	SIZE in	SHAPE
BO-0267	14.5 cm	5¾"	str

**Metzenbaum-Fino**  
Delicate Dissecting Scissors  
slender pattern



REF #	SIZE cm	SIZE in	SHAPE
BO-0268	14.5 cm	5¾"	cvd

**Metzenbaum-Fino**  
Delicate Dissecting Scissors  
slender pattern



REF #	SIZE cm	SIZE in	SHAPE
BO-0269	18.0 cm	7"	str srp-srp
BO-0270	20.0 cm	8"	str srp-srp
BO-0271	23.0 cm	9"	str srp-srp

**Metzenbaum-Fino**  
Delicate Dissecting Scissors  
slender pattern



REF #	SIZE cm	SIZE in	SHAPE
BO-0272	18.0 cm	7"	cvd
BO-0273	20.0 cm	8"	cvd
BO-0274	23.0 cm	9"	cvd

**Metzenbaum-Fino**  
Delicate Dissecting Scissors  
slender pattern



REF #	SIZE cm	SIZE in	SHAPE
BO-0275	18.0 cm	7"	S-shape
BO-0276	20.0 cm	8"	S-shape
BO-0277	23.0 cm	9"	S-shape

**Metzenbaum-Fino**  
Delicate Dissecting Scissors  
slender pattern



REF #	SIZE cm	SIZE in	SHAPE
BO-0278	14.0 cm	5½"	str
BO-0279	14.0 cm	5½"	cvd

**Sanvenero**  
Operating Scissors



REF #	SIZE cm	SIZE in	SHAPE
BO-0280	11.5 cm	4½"	str
BO-0281	11.5 cm	4½"	cvd

**Standard**  
Dissecting Scissors



REF #	SIZE cm	SIZE in	SHAPE
BO-0282	14.5 cm	5¾"	str
BO-0283	14.5 cm	5¾"	cvd

**Joseph**  
Operating Scissors



REF #	SIZE cm	SIZE in	SHAPE
BO-0284	14.5 cm	5¾"	str
BO-0285	14.5 cm	5¾"	cvd

**Peck-Joseph**  
Face-lift Scissors

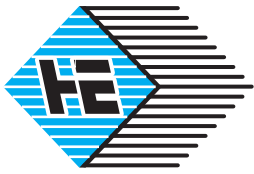

## GENERAL INSTRUMENTS

### SCISSORS

Dissecting Scissors, Face-Lift Scissors, Vascular Scissors



REF #	SIZE cm	SIZE in	SHAPE
BO-0286	14.5 cm	5 3/4"	str
BO-0287	14.5 cm	5 3/4"	cvd

**Peck-Joseph**  
Face-lift Scissors



REF #	SIZE cm	SIZE in	SHAPE
BO-0288	12.0 cm	4 3/4"	cvd

**Shea Vein Graft**  
Dissecting Scissors



REF #	SIZE cm	SIZE in	SHAPE
BO-0289	12.0 cm	4 3/4"	cvd
BO-0290	15.0 cm	6"	cvd

**Kilner**  
Dissecting Scissors



REF #	SIZE cm	SIZE in	SHAPE
BO-0291	14.5 cm	5 3/4"	str
BO-0292	14.5 cm	5 3/4"	cvd

**Standard**  
Dissecting Scissors



REF #	SIZE cm	SIZE in	SHAPE
BO-0293	15.5 cm	6"	str
BO-0294	15.5 cm	6"	cvd
BO-0295	18.0 cm	7"	cvd

**Reynolds**  
Dissecting Scissors



REF #	SIZE cm	SIZE in	SHAPE
BO-0296	15.5 cm	6"	cvd

**Jameson**  
Dissecting Scissors



REF #	SIZE cm	SIZE in	SHAPE
BO-0297	15.5 cm	6"	cvd

**Jameson**  
Dissecting Scissors  
one toothed cutting edge



REF #	SIZE cm	SIZE in	SHAPE
BO-0298	19.0 cm	7 1/2"	str
BO-0299	19.0 cm	7 1/2"	cvd

**Standard**  
Vascular Scissors  
fine, short blades



REF #	SIZE cm	SIZE in	SHAPE
BO-0300	25.5 cm	10"	S-shape

**Standard**  
Vascular Scissors

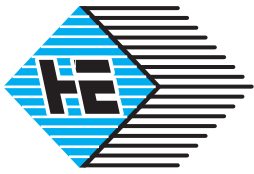

## GENERAL INSTRUMENTS

### SCISSORS

Vascular Scissors, Coronary Scissors, Neurosurgical Scissors,  
Dura Scissors



**Diethrich**  
Vascular Scissors

REF #	SIZE cm	SIZE in	SHAPE
BO-0301	19.0 cm	7½"	25° angled
BO-0302	18.5 cm	7¼"	45° angled
BO-0303	18.5 cm	7¼"	60° angled
BO-0304	17.5 cm	7"	90° angled
BO-0305	17.5 cm	7"	125° angled



**Diethrich**  
Vascular Scissors  
with guiding

REF #	SIZE cm	SIZE in	SHAPE
BO-0306	19.0 cm	7"	125° angled



**DeBakey**  
Vascular Scissors

REF #	SIZE cm	SIZE in	SHAPE
BO-0307	16.5 cm	6½"	45° angled
BO-0308	16.0 cm	6¼"	60° angled



**Potts-Smith**  
Vascular Scissors

REF #	SIZE cm	SIZE in	SHAPE
BO-0309	19.0 cm	7½"	25° angled
BO-0310	19.0 cm	7½"	40° angled
BO-0311	19.0 cm	7½"	60° angled
BO-0312	19.0 cm	7½"	60° bend
BO-0313	19.0 cm	7½"	60° angled ball / srp blade edges



**Standard**  
Coronary Scissor  
Micro Scissors

REF #	SIZE cm	SIZE in	SHAPE
BO-0314	18.0 cm	7"	25° angled
BO-0315	18.0 cm	7"	45° angled
BO-0316	18.0 cm	7"	60° angled
BO-0317	18.0 cm	7"	90° angled
BO-0318	18.0 cm	7"	125° angled

Blade length 10 mm



**Favoloro**  
Vascular Scissors

REF #	SIZE cm	SIZE in
BO-0319	15.0 cm	6"



**Standard**  
Vascular Scissors

REF #	SIZE cm	SIZE in	SHAPE
BO-0320	12.0 cm	4¾"	str

one blade pointed



**Strully**  
Neurosurgical Scissors

REF #	SIZE cm	SIZE in	SHAPE
BO-0321	22.5 cm	8¾"	cvd



**Schmieden-Taylor**  
Dura Scissors

REF #	SIZE cm	SIZE in
BO-0322	16.5 cm	6½"

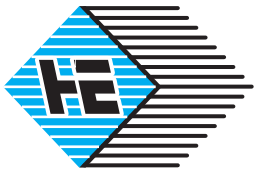

## GENERAL INSTRUMENTS

### SCISSORS

Dissecting Scissors, Trigeminal Scissors, Tonsil Scissors,  
Nasal Scissors



REF #	SIZE cm	SIZE in	SHAPE
BO-0323	17.5 cm	7"	cvd

**Toennis-Adson**  
Dissecting Scissors  
slender pattern

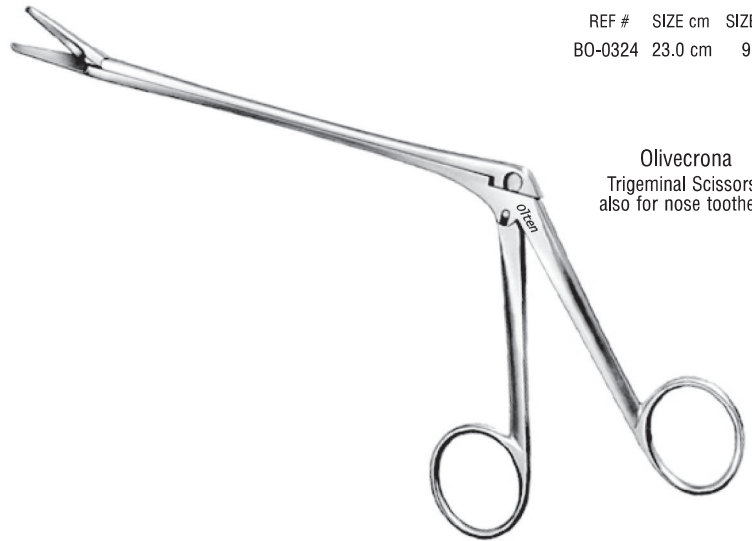

REF #	SIZE cm	SIZE in
BO-0324	23.0 cm	9"

**Olivecrona**  
Trigeminal Scissors  
also for nose toothed



REF #	SIZE cm	SIZE in	SHAPE
BO-0325	17.5 cm	7"	angled upwards
BO-0326	17.5 cm	7"	angled upwards toothed

**Dean**  
Tonsil Scissors



REF #	SIZE cm	SIZE in	SHAPE
BO-0327	19.5 cm	7¾"	cvd

**Good**  
Tonsil Scissors



REF #	SIZE cm	SIZE in
BO-0328	15.0 cm	5"

**Fomon**  
Nasal Scissors



REF #	SIZE cm	SIZE in
BO-0329	16.0 cm	6¼"

**Cottle**  
Nasal Scissors



REF #	SIZE cm	SIZE in
BO-0330	18.5 cm	7¼"

**Heymann**  
Nasal Scissors



REF #	SIZE cm	SIZE in
BO-0331	18.5 cm	7¼"

**Heymann**  
Nasal Scissors  
one toothed cutting edge



## GENERAL INSTRUMENTS

### SCISSORS

Nasal Scissors, Episiotomy Scissors, Umbilical Scissors,  
Gum Scissors

**Olten**  
Instruments



REF #	SIZE cm	SIZE in	SHAPE
BO-0332	10.5 cm	4 1/4"	srp-srp
BO-0333	10.5 cm	4 1/4"	blt-blt

**Converse**  
Nasal Scissors (angled upward)



REF #	SIZE cm	SIZE in
BO-0334	18.0 cm	7"

**Waldmann**  
Episiotomy Scissors  
one toothed cutting edge



REF #	SIZE cm	SIZE in
BO-0335	14.5 cm	5 1/2"

**Braun-Stadler**  
Episiotomy Scissors



REF #	SIZE cm	SIZE in
BO-0336	22.0 cm	8 3/4"

**Braun-Stadler**  
Episiotomy Scissors



REF #	SIZE cm	SIZE in
BO-0337	10.5 cm	4 1/4"

**Modell USA**  
Umbilical Scissors



REF #	SIZE cm	SIZE in
BO-0338	16.0 cm	6 1/4"

**Schuhmacher**  
Umbilical Scissors



REF #	SIZE cm	SIZE in
BO-0339	16.0 cm	6 1/4"

**Busch**  
Umbilical Scissors



REF #	SIZE cm	SIZE in
BO-0340	16.0 cm	6 1/4"

**Busch**  
Umbilical Scissors  
one toothed cutting edge



REF #	SIZE cm	SIZE in	SHAPE
BO-0341	13.0 cm	5"	str
BO-0342	13.0 cm	5"	cvd

**Goldmann-Fox**  
Gum Scissors (one toothed cutting edge)

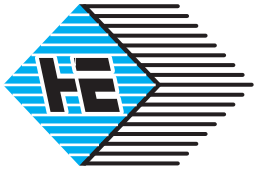

## GENERAL INSTRUMENTS

### SCISSORS

Operating Scissors, Gum Scissors, Dissecting Scissors,  
Iris Scissors



**Wagner**  
Operating Scissors

REF #	SIZE cm	SIZE in	SHAPE
BO-0343	12.0 cm	4 3/4"	str
BO-0344	12.0 cm	4 3/4"	cvd



**Standard**  
Operating Scissors (small model)

REF #	SIZE cm	SIZE in	SHAPE
BO-0345	12.0 cm	4 3/4"	str
BO-0346	12.0 cm	4 3/4"	cvd

with srp-srp blade edges

REF #	SIZE cm	SIZE in	SHAPE
BO-0347	12.0 cm	4 3/4"	str
BO-0348	12.0 cm	4 3/4"	cvd

with srp-blt blade edges



**La Grange**  
Gum Scissors

REF #	SIZE cm	SIZE in	SHAPE
BO-0349	11.5 cm	4 1/2"	S-shape



**Standard**  
Dissecting Scissors (delicate)

REF #	SIZE cm	SIZE in	SHAPE
BO-0350	11.5 cm	4 1/2"	str
BO-0351	11.5 cm	4 1/2"	cvd



**Locklin**  
Gum Scissors  
one toothed cutting edge

REF #	SIZE cm	SIZE in
BO-0352	16.0 cm	6 1/4"



**Locklin**  
Gum Scissors  
one toothed cutting edge

REF #	SIZE cm	SIZE in
BO-0353	16.0 cm	6 1/4"



**Standard**  
Operating Scissors  
very delicate

REF #	SIZE cm	SIZE in	SHAPE
BO-0354	09.0 cm	3 1/2"	str
BO-0355	09.0 cm	3 1/2"	cvd



**Standard**  
Iris Scissors

REF #	SIZE cm	SIZE in	SHAPE
BO-0356	09.0 cm	3 1/2"	str
BO-0357	10.0 cm	4"	str
BO-0358	09.0 cm	3 1/2"	cvd
BO-0359	10.0 cm	4"	cvd



**Standard**  
Iris Scissors (extra flat blades)

REF #	SIZE cm	SIZE in	SHAPE
BO-0360	10.0 cm	4"	str



## GENERAL INSTRUMENTS

### SCISSORS

Iris Scissors, Tendon Scissors, Steabismus Scissors, Enucleation Scissors, Micro Scissors



REF #	SIZE cm	SIZE in	SHAPE
BO-0361	09.0 cm	3½"	str



**Bonn**  
Iris Scissors

REF #	SIZE cm	SIZE in	SHAPE
BO-0362	09.0 cm	3½"	cvd



**Bonn**  
Iris Scissors

REF #	SIZE cm	SIZE in	SHAPE
BO-0363	10.5 cm	4"	str
BO-0364	11.5 cm	4½"	str
BO-0365	10.5 cm	4"	cvd
BO-0366	11.5 cm	4½"	cvd



**Standard**  
Iris Scissors

REF #	SIZE cm	SIZE in
BO-0367	10.5 cm	4¼"

REF #	SIZE cm	SIZE in
BO-0368	11.5 cm	4½"

REF #	SIZE cm	SIZE in	SHAPE
BO-0369	12.5 cm	5"	str
BO-0370	12.5 cm	5"	cvd



**Standard**  
Iris Scissors

REF #	SIZE cm	SIZE in	SHAPE
BO-0371	11.0 cm	4¼"	str
BO-0372	11.0 cm	4¼"	cvd



**Stevens**  
Tendon Scissors (sharp edges)

REF #	SIZE cm	SIZE in	SHAPE
BO-0373	11.0 cm	4½"	str
BO-0374	11.0 cm	4½"	cvd



**Stevens**  
Tendon Scissors (blunt edges)

REF #	SIZE cm	SIZE in	SHAPE
BO-0375	11.5 cm	4½"	str
BO-0376	11.5 cm	4½"	cvd



**Standard**  
Strabismus Scissors

REF #	SIZE cm	SIZE in	SHAPE
BO-0377	11.5 cm	4½"	cvd



**Standard**  
Enucleation Scissors

REF #	SIZE cm	SIZE in	SHAPE
BO-0378	15.0 cm	6"	str
BO-0379	18.0 cm	7"	str
BO-0380	21.0 cm	8¼"	str
BO-0381	23.0 cm	9"	str
BO-0382	15.0 cm	6"	cvd
BO-0383	18.0 cm	7"	cvd
BO-0384	21.0 cm	8¼"	cvd
BO-0385	23.0 cm	9"	cvd



**Standard**  
Micro Scissors (round handle)

blade length 10 mm



## GENERAL INSTRUMENTS

### SCISSORS Micro Scissors



REF #	SIZE cm	SIZE in	SHAPE
BO-0386	10.0 cm	4"	str



Standard  
Micro Dissecting Scissors

REF #	SIZE cm	SIZE in	SHAPE
BO-0387	15.0 cm	6"	str
BO-0388	18.0 cm	7"	str
BO-0389	21.0 cm	8½"	str
BO-0390	23.0 cm	9"	str
BO-0391	15.0 cm	6"	cvd
BO-0392	18.0 cm	7"	cvd
BO-0393	21.0 cm	8½"	cvd
BO-0394	23.0 cm	9"	cvd



Standard  
Micro Scissors (flat handle)

blade length 10 mm

REF #	SIZE cm	SIZE in
BO-0395	10.0 cm	4"



Standard  
Micro Dissecting Scissors

REF #	SIZE cm	SIZE in	SHAPE
BO-0396	23.0 cm	9"	str
BO-0397	22.5 cm	9"	cvd



Jacobson  
Micro Scissors

REF #	SIZE cm	SIZE in	SHAPE
BO-0398	21.0 cm	8½"	str
BO-0399	21.0 cm	8½"	cvd



REF #	SIZE cm	SIZE in	SHAPE
BO-0400	11.5 cm	4½"	str
BO-0401	11.5 cm	4½"	cvd



Westcott  
Strabismus Scissors

REF #	SIZE cm	SIZE in	SHAPE
BO-0402	18.5 cm	7½"	str
BO-0403	18.5 cm	7½"	cvd



Standard  
Micro Scissors

REF #	SIZE cm	SIZE in	SHAPE
BO-0404	19.0 cm	7½"	str
BO-0405	18.5 cm	7½"	cvd
BO-0406	18.5 cm	7½"	cvd reverse



Standard  
Micro Scissors

REF #	SIZE cm	SIZE in	SHAPE
BO-0407	12.0 cm	4¾"	cvd



Standard  
Micro Scissors

REF #	SIZE cm	SIZE in	SHAPE
BO-0408	12.0 cm	4¾"	str



Standard  
Micro Scissors

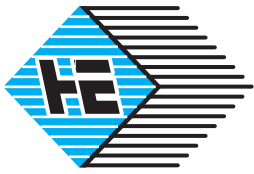

## GENERAL INSTRUMENTS

### SCISSORS

Micro Scissors, Entotomy Scissors, Dissecting Scissors



REF # SIZE cm SIZE in SHAPE  
BO-0409 21.5 cm 8½" str

Salyer  
Enterotomy Scissors



REF # SIZE cm SIZE in SHAPE  
BO-0410 10.0 cm 4" cvd

Salyer  
Dissecting Scissors (for Cleft Palate)



REF # SIZE cm SIZE in  
BO-0411 18.0 cm 7"

blade length 12 mm

JABOMA  
Micro Scissors (for Cleft Palate)



REF # SIZE cm SIZE in  
BO-0412 18.0 cm 7"

blade length 12 mm

JABOMA  
Micro Scissors (for Cleft Palate)



REF # SIZE cm SIZE in  
BO-0413 18.0 cm 7"

blade length 12 mm

JABOMA  
Micro Scissors (for Cleft Palate)



REF # SIZE cm SIZE in SHAPE  
BO-0414 15.5 cm 6" str  
BO-0415 15.5 cm 6" cvd

Standard  
Micro Scissors



Standard  
Micro Scissors

REF # SIZE cm SIZE in SHAPE  
BO-0416 15.5 cm 6" str  
BO-0417 15.5 cm 6" cvd



Standard  
Enterotomy Scissors

REF # SIZE cm SIZE in SHAPE  
BO-0418 21.5 cm 8½" str



Salyer  
Dissecting Scissors (for cleft Plate)

REF # SIZE cm SIZE in SHAPE  
BO-0419 09.0 cm 3¾" cvd

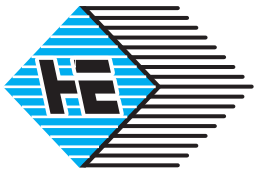

## GENERAL INSTRUMENTS

### SCISSORS

Wire Cutting Scissors, Rectal Scissors, Face-Lift Scissors  
Stitch Scissors

**Olten**  
Instruments



REF # SIZE cm SIZE in  
BO-0420 12.0 cm 4¾"

**Universal**  
Wire Cutting Scissors (toothed)



REF # SIZE cm SIZE in SHAPE  
BO-0421 32.5 cm 12¾" cvd

**Standard**  
Rectal Scissors (heavy pattern)



REF # SIZE cm SIZE in SHAPE  
BO-0422 10.5 cm 4¼" str  
BO-0423 10.5 cm 4¼" cvd

**Beebee**  
Wire Cutting Scissors

BO-0424 12.0 cm 4¾" str  
BO-0425 12.0 cm 4¾" cvd  
one toothed cutting edge



REF # SIZE cm SIZE in SHAPE  
BO-0426 11.0 cm 4½" cvd

**Kaye**  
Face-lift Scissors (toothed)



REF # SIZE cm SIZE in SHAPE  
BO-0427 13.0 cm 5"

**Northbent**  
Stitch Scissors



REF # SIZE cm SIZE in SHAPE  
BO-0428 09.0 cm 3½" str

**Spencer**  
Stitch Scissors



REF # SIZE cm SIZE in SHAPE  
BO-0429 11.5 cm 4½" str  
BO-0430 13.0 cm 5" str

**Spencer**  
Stitch Scissors



REF # SIZE cm SIZE in SHAPE  
BO-0431 14.5 cm 5¾" str  
BO-0432 18.0 cm 7" str

**Buck**  
Stitch Scissors



REF # SIZE cm SIZE in SHAPE  
BO-0433 14.0 cm 5½" str

**Littauer**  
Stitch Scissors

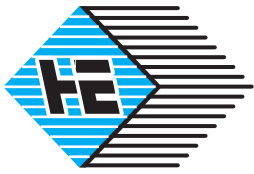

## GENERAL INSTRUMENTS

### SCISSORS

Stitch Scissors, Dissecting Scissors



REF #	SIZE cm	SIZE in	SHAPE
BO-0434	12.0 cm	4¾"	str

Eiselsberg  
Stitch Scissors



REF #	SIZE cm	SIZE in	SHAPE
BO-0435	18.0 cm	7"	cvd
BO-0436	20.0 cm	8"	cvd
BO-0437	23.0 cm	9"	cvd

Metzenbaum  
Dissecting Scissors  
with special cutting edge



REF #	SIZE cm	SIZE in	SHAPE
BO-0438	14.5 cm	5¾"	cvd
BO-0439	18.0 cm	7"	cvd

Metzenbaum  
Dissecting Scissors  
with special cutting edge



REF #	SIZE cm	SIZE in	SHAPE
BO-0440	16.0 cm	6¾"	cvd

(with special cutting edge)

Mayo-Lexer  
Dissecting Scissors  
slender pattern

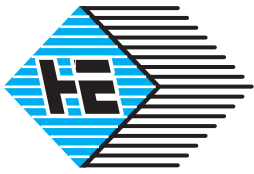

## GENERAL INSTRUMENTS

### SCISSORS

Dissecting Scissors, Nasal Scissors, Operating Scissors, Stitch Scissors

**Tungsten Carbide  
Inserted (TC)**

**Olten  
Instruments**



REF #	SIZE cm	SIZE in	SHAPE
BO-0441	12.5 cm	5"	cvd
BO-0442	18.0 cm	7"	cvd

**Salyer**  
Dissecting Scissors for Cleft Palate  
fine pattern



REF #	SIZE cm	SIZE in	SHAPE
BO-0443	12.0 cm	4 3/4"	45°angled

**Diethrich-Salyer**  
Dissecting Scissors (for Cleft Palate)



REF #	SIZE cm	SIZE in
BO-0444	14.5 cm	5 3/8"

**Fomon**  
Nasal Scissors



REF #	SIZE cm	SIZE in
BO-0445	16.0 cm	6 1/4"

**Cottle**  
Nasal Scissors



REF #	SIZE cm	SIZE in	SHAPE
BO-0446	14.5 cm	5 3/4"	str blt/blt
BO-0447	14.5 cm	5 3/4"	str srp/blt
BO-0448	14.5 cm	5 3/4"	str srp/srp
BO-0449	14.5 cm	5 3/4"	cvd blt/blt
BO-0450	14.5 cm	5 3/4"	cvd srp/blt
BO-0451	14.5 cm	5 3/4"	cvd srp/srp

**Standard**  
Operating Scissors



REF #	SIZE cm	SIZE in	SHAPE
BO-0452	14.5 cm	5 3/4"	str
BO-0453	17.0 cm	6 3/4"	str
BO-0454	23.0 cm	9"	str
BO-0455	14.5 cm	5 3/4"	cvd
BO-0456	17.0 cm	6 3/4"	cvd
BO-0457	23.0 cm	9"	cvd

**Mayo**  
Operating Scissors



REF #	SIZE cm	SIZE in	SHAPE
BO-0458	14.5 cm	5 3/4"	str
BO-0459	17.0 cm	6 3/4"	str
BO-0460	14.5 cm	5 3/4"	cvd
BO-0461	17.0 cm	6 3/4"	cvd

**Mayo-Stille**  
Dissecting Scissors



REF #	SIZE cm	SIZE in	SHAPE
BO-0462	11.5 cm	4 1/2"	str
BO-0463	14.5 cm	5 3/4"	str
BO-0464	11.5 cm	4 1/2"	cvd
BO-0465	14.5 cm	5 3/4"	cvd

**Metzenbaum**  
Dissecting Scissors



REF #	SIZE cm	SIZE in	SHAPE
BO-0466	14.5 cm	5 3/4"	cvd
BO-0467	18.0 cm	7"	cvd
BO-0468	20.5 cm	8"	cvd
BO-0469	23.0 cm	9"	cvd
BO-0470	25.0 cm	9 3/4"	cvd

**Standard**  
Stitch Scissors

for synthetic suture material  
one toothed cutting edge

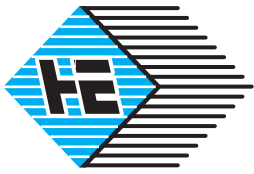

## GENERAL INSTRUMENTS

### SCISSORS

Ligature Scissors, Dissecting Scissors  
Delicate Dissecting Scissors, Operating Scissors,

**Tungsten Carbide  
Inserted (TC)**



**Standard  
Ligature Scissors**

REF #	SIZE cm	SIZE in	SHAPE
BO-0471	14.5 cm	5¾"	cvd
BO-0472	17.0 cm	6¾"	cvd
BO-0473	23.0 cm	9"	cvd

for synthetic suture material  
one toothed cutting edge



**Lexel  
Dissecting Scissors**

REF #	SIZE cm	SIZE in	SHAPE
BO-0474	16.0 cm	6¼"	str
BO-0475	21.0 cm	8¼"	str
BO-0476	16.0 cm	6¼"	cvd
BO-0477	21.0 cm	8¼"	cvd



**Mayo-Lexel  
Dissecting Scissors**

REF #	SIZE cm	SIZE in	SHAPE
BO-0478	16.0 cm	6¼"	cvd



**Metzenbaum-Fino  
Delicate Dissecting Scissors**

REF #	SIZE cm	SIZE in	SHAPE
BO-0479	18.0 cm	7"	
BO-0480	20.0 cm	8"	

Slender pattern



**Metzenbaum-Fino  
Delicate Dissecting Scissors  
Blunt / Blunt**

REF #	SIZE cm	SIZE in	SHAPE
BO-0481	14.5 cm	5¾"	str
BO-0482	18.0 cm	7"	str
BO-0483	20.5 cm	8"	str
BO-0484	23.0 cm	9"	str
BO-0485	26.0 cm	10¼"	str
BO-0486	28.5 cm	11¼"	str
BO-0487	14.5 cm	5¾"	cvd
BO-0488	18.0 cm	7"	cvd
BO-0489	20.5 cm	8"	cvd
BO-0490	23.0 cm	9"	cvd
BO-0491	26.0 cm	10¼"	cvd
BO-0492	28.5 cm	11¼"	cvd



**Metzenbaum  
Dissecting Scissors (Delicate)**

REF #	SIZE cm	SIZE in	SHAPE
BO-0493	18.0 cm	7"	str
BO-0494	20.5 cm	8"	str
BO-0495	23.0 cm	9"	str
BO-0496	26.0 cm	10¼"	str
BO-0497	28.5 cm	11¼"	str
BO-0498	31.0 cm	12¼"	str
BO-0499	18.0 cm	7"	cvd
BO-0500	20.5 cm	8"	cvd
BO-0501	23.0 cm	9"	cvd
BO-0502	26.0 cm	10¼"	cvd
BO-0503	28.5 cm	11¼"	cvd
BO-0504	31.0 cm	12¼"	cvd



**Metzenbaum-Fino  
Delicate Dissecting Scissors**

REF #	SIZE cm	SIZE in	SHAPE
BO-0505	14.5 cm	5¾"	str
BO-0506	14.5 cm	5¾"	cvd



**Metzenbaum-Thorek  
Dissecting Scissors**

REF #	SIZE cm	SIZE in	SHAPE
BO-0507	20.0 cm	8"	cvd
BO-0508	23.0 cm	9"	cvd
BO-0509	28.0 cm	11"	cvd



**Joseph  
Operating Scissors**

REF #	SIZE cm	SIZE in	SHAPE
BO-0510	14.5 cm	5¾"	str
BO-0511	14.5 cm	5¾"	cvd



## GENERAL INSTRUMENTS

### SCISSORS

Dissecting Scissors, Delicate Dissecting Scissors, Face-Lift Scissors, Hysterectomy Scissors, Ligature Scissors

**Tungsten Carbide  
Inserted (TC)**

**Olten  
Instruments**



REF #	SIZE cm	SIZE in	SHAPE
BO-0512	14.5 cm	5¾"	cvd

Slender pattern

Metzenbaum-Lahey  
Dissecting Scissors



REF #	SIZE cm	SIZE in	SHAPE
BO-0513	17.5 cm	7"	cvd

Slender pattern

Metzenbaum-Lahey  
Dissecting Scissors



REF #	SIZE cm	SIZE in	SHAPE
BO-0514	20.5 cm	8"	cvd
BO-0515	23.0 cm	9"	cvd

slender pattern

Metzenbaum-Lahey  
Delicate Dissecting Scissors



REF #	SIZE cm	SIZE in
BO-0516	18.0 cm	7"
BO-0517	20.5 cm	8"
BO-0518	23.0 cm	9"

slender pattern

Metzenbaum-Fino  
Delicate Dissecting Scissors



REF #	SIZE cm	SIZE in	SHAPE
BO-0519	20.0 cm	8"	str
BO-0520	23.0 cm	9"	str

one toothed cutting edge

Gorney  
Face-lift Scissors



REF #	SIZE cm	SIZE in	SHAPE
BO-0521	17.0 cm	6¾"	cvd

one toothed cutting edge

Rees  
Face-lift Scissors



REF #	SIZE cm	SIZE in	SHAPE
BO-0522	23.0 cm	9"	str
BO-0523	23.0 cm	9"	cvd

Sims  
Uterine Scissors



REF #	SIZE cm	SIZE in	SHAPE
BO-0524	22.5 cm	8¾"	cvd
BO-0525	23.0 cm	9"	semi-cvd

Parametrium  
Hysterectomy Scissors



REF #	SIZE cm	SIZE in	SHAPE
BO-0526	13.0 cm	5"	str
BO-0527	13.0 cm	5"	cvd

Goldmann-Fox  
Ligature Scissors



## GENERAL INSTRUMENTS

### FORCEPS Dressing Forceps,



REF #	SIZE cm	SIZE in	SHAPE
CO-0592	12.0 cm	4¾"	str
CO-0593	13.0 cm	5"	str
CO-0594	14.5 cm	5¾"	str
CO-0595	16.0 cm	6¾"	str
CO-0596	18.0 cm	7"	str
CO-0597	20.0 cm	8"	str
CO-0598	25.0 cm	9¾"	str
CO-0599	30.5 cm	11¾"	str

Standard  
Dressing Forceps (slender pattern)



REF #	SIZE cm	SIZE in	SHAPE
CO-0600	11.0 cm	4½"	str
CO-0601	13.0 cm	5"	str
CO-0602	14.5 cm	5½"	str
CO-0603	16.0 cm	6¾"	str
CO-0604	18.0 cm	7"	str
CO-0605	20.0 cm	8"	str
CO-0606	25.0 cm	10"	str
CO-0607	30.0 cm	12"	str

Standard  
Dressing Forceps (slender pattern)



REF #	SIZE cm	SIZE in	SHAPE
CO-0608	13.0 cm	5"	str
CO-0609	14.5 cm	5¾"	str

Standard  
Dressing Forceps (slender pattern)



REF #	SIZE cm	SIZE in	SHAPE
CO-0610	15.0 cm	6"	str

Standard  
Dressing Forceps



REF #	SIZE cm	SIZE in	SHAPE
CO-0611	12.0 cm	4¾"	str

Mini-Adson  
Dressing Forceps



REF #	SIZE cm	SIZE in	SHAPE
CO-0612	12.0 cm	4¾"	str
CO-0613	15.0 cm	6"	str

Adson  
Dressing Forceps



REF #	SIZE cm	SIZE in	SHAPE
CO-0614	15.0 cm	6"	str

McIndoe  
Dressing Forceps



REF #	SIZE cm	SIZE in	SHAPE
CO-0615	20.0 cm	8"	str

Vaugh  
Dressing Forceps



REF #	SIZE cm	SIZE in	SHAPE
CO-0616	12.5 cm	5"	str
CO-0617	15.0 cm	6"	str

Semken  
Dressing Forceps

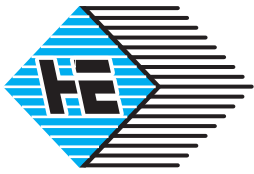

## GENERAL INSTRUMENTS

### FORCEPS Dressing Forceps, Dissecting Forceps



REF #	SIZE cm	SIZE in	SHAPE
CO-0618	17.0 cm	6¾"	str

Taylor  
Dressing Forceps



REF #	SIZE cm	SIZE in	SHAPE
CO-0619	17.0 cm	6¾"	str

Taylor  
Dressing Forceps (with dissector end)



REF #	SIZE cm	SIZE in	SHAPE
CO-0620	18.5 cm	7¼"	bayonet

Taylor  
Dressing Forceps (with dissector end)



REF #	SIZE cm	SIZE in	TIP SIZE	SHAPE
CO-0621	15.5 cm	6"	0.6 mm	str
CO-0622	15.5 cm	6"	0.8 mm	str
CO-0623	15.5 cm	6"	1.0 mm	str

Standard  
Micro Dressing Forceps



REF #	SIZE cm	SIZE in	SHAPE
CO-0624	17.5 cm	7"	str
CO-0625	17.5 cm	7"	cvd

Gerald  
Dressing Forceps



REF #	SIZE cm	SIZE in	SHAPE
CO-0626	17.5 cm	7"	str
CO-0627	17.5 cm	7"	cvd

Cushing  
Dressing Forceps



REF #	SIZE cm	SIZE in	SHAPE
CO-0628	18.0 cm	7"	str
CO-0629	21.0 cm	8¼"	str
CO-0630	24.5 cm	9¾"	str

Potts-Smith  
Dressing Forceps



REF #	SIZE cm	SIZE in	SHAPE
CO-0631	15.5 cm	6"	str
CO-0632	17.5 cm	7"	str
1x2 teeth (normal profile)			
CO-0633	15.5 cm	6"	str
CO-0634	17.5 cm	7"	str
1x2 teeth (mini profile)			

Semken  
Dissecting Forceps



REF #	SIZE cm	SIZE in	SHAPE
CO-0635	10.5 cm	4"	str
CO-0636	11.5 cm	4½"	str
CO-0637	13.0 cm	5"	str
CO-0638	14.5 cm	5¾"	str
CO-0639	16.0 cm	6¼"	str
CO-0640	18.0 cm	7"	str
CO-0641	20.0 cm	8"	str
CO-0642	23.0 cm	9"	str
CO-0643	25.0 cm	9¾"	str
CO-0644	30.5 cm	12"	str

Standard  
Dissecting Forceps (standard pattern)

1x2 teeth

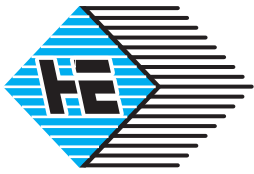

# GENERAL INSTRUMENTS

## FORCEPS Dissecting Forceps,



REF #	SIZE cm	SIZE in	SHAPE
CO-0645	12.0 cm	4¾"	str
CO-0646	13.0 cm	5"	str
CO-0647	14.5 cm	5½"	str
CO-0648	15.5 cm	6"	str
CO-0649	18.0 cm	7"	str
CO-0650	20.0 cm	8"	str
CO-0651	24.5 cm	9¾"	str

2x3 teeth

Standard  
Dissecting Forceps



REF #	SIZE cm	SIZE in	SHAPE
CO-0652	14.5 cm	5¾"	str
CO-0653	16.0 cm	6¼"	str

3x4 teeth

Standard  
Dissecting Forceps



REF #	SIZE cm	SIZE in	SHAPE
CO-0654	14.5 cm	5¾"	str
CO-0655	16.0 cm	6¼"	str

4x5 teeth

Standard  
Dissecting Forceps



REF #	SIZE cm	SIZE in	SHAPE
CO-0656	13.0 cm	5"	str
CO-0657	14.5 cm	5¾"	str
CO-0658	16.0 cm	6¼"	str
CO-0659	20.0 cm	8"	str

1x2 teeth

Standard  
Dissecting Forceps (slender pattern)



REF #	SIZE cm	SIZE in	SHAPE
CO-0660	13.0 cm	5"	str
CO-0661	14.5 cm	5½"	str

1x2 teeth

Standard  
Dissecting Forceps



REF #	SIZE cm	SIZE in	SHAPE
CO-0662	15.0 cm	6"	str

1x2 teeth

Stille  
Dissecting Forceps



REF #	SIZE cm	SIZE in	SHAPE
CO-0663	15.0 cm	6"	str

2x3 teeth

Stille  
Dissecting Forceps



REF #	SIZE cm	SIZE in	SHAPE
CO-0664	15.0 cm	6"	str

4x5 teeth

Stone  
Dissecting Forceps



REF #	SIZE cm	SIZE in	SHAPE
CO-0665	15.0 cm	6"	str

5x6 teeth

Lerche  
Dissecting Forceps

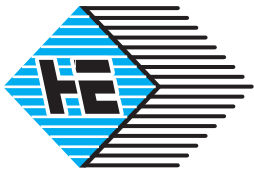

## GENERAL INSTRUMENTS

### FORCEPS

Dissecting Forceps, Micro Dissecting Forceps



REF #	SIZE cm	SIZE in	SHAPE
CO-0666	15.5 cm	6"	str
CO-0667	20.5 cm	8"	str

2x3 teeth

CO-0668	16.0 cm	6¼"	str
CO-0669	20.0 cm	8"	str
CO-0670	25.0 cm	9¾"	str

4x5 teeth

**Adlerkreutz**  
Dissecting Forceps



REF #	SIZE cm	SIZE in	SHAPE
CO-0671	12.0 cm	4¾"	str
CO-0672	15.0 cm	6"	str

1x2 teeth

**Adson**  
Dissecting Forceps



REF #	SIZE cm	SIZE in	SHAPE
CO-0673	15.5 cm	6"	str

1x2 teeth

**Gillies**  
Dissecting Forceps



REF #	SIZE cm	SIZE in	SHAPE
CO-0674	20.5 cm	8"	str

1x2 teeth

**Waugh**  
Dissecting Forceps



REF #	SIZE cm	SIZE in	SHAPE
CO-0675	12.5 cm	5"	str
CO-0676	15.0 cm	6"	str

1x2 teeth

**Semken**  
Dissecting Forceps



REF #	SIZE cm	SIZE in	SHAPE
CO-0677	17.5 cm	7"	str

1x2 teeth

**Taylor**  
Dissecting Forceps



REF #	SIZE cm	SIZE in	SHAPE
CO-0678	17.0 cm	6¾"	str

1x2 teeth

**Taylor**  
Dissecting Forceps (with dissector end)



REF #	SIZE cm	SIZE in	SHAPE
CO-0679	18.5 cm	7¼"	bayonet

1x2 teeth

**Taylor**  
Dissecting Forceps (with dissector end)



REF #	SIZE cm	SIZE in	TIP SIZE	SHAPE
CO-0680	15.5 cm	6"	0.6 mm	str
CO-0681	15.5 cm	6"	0.8 mm	str
CO-0682	15.5 cm	6"	1.0 mm	str

1x2 teeth

**Standard**  
Micro Dissecting Forceps

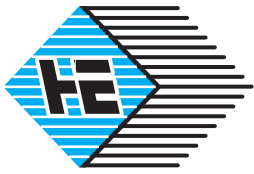

## GENERAL INSTRUMENTS

### FORCEPS

Dissecting Forceps, Dressing Forceps

**Olten**  
Instruments



REF #	SIZE cm	SIZE in	SHAPE
CO-0683	17.5 cm	7"	str

1x2 teeth

Gerald  
Dissecting Forceps



REF #	SIZE cm	SIZE in	SHAPE
CO-0684	18.0 cm	7"	str

1x2 teeth

Cushing  
Dissecting Forceps



REF #	SIZE cm	SIZE in	SHAPE
CO-0685	18.0 cm	7 $\frac{1}{4}$ "	str
CO-0686	21.0 cm	8 $\frac{1}{4}$ "	str
CO-0687	24.0 cm	9 $\frac{1}{2}$ "	str

1x2 teeth

Potts-Smith  
Dissecting Forceps



REF #	SIZE cm	SIZE in	SHAPE
CO-0688	20.0 cm	8"	str

Rees  
Dressing Forceps for coagulation



REF #	SIZE cm	SIZE in	SHAPE
CO-0689	12.0 cm	5"	str

7x7 teeth

Adson Brown  
Dissecting Forceps



REF #	SIZE cm	SIZE in	SHAPE
CO-0690	12.0 cm	4 $\frac{3}{4}$ "	str

1x2 teeth

Mini-Adson  
Dissecting Forceps



REF #	SIZE cm	SIZE in	SHAPE
CO-0691	12.0 cm	4 $\frac{3}{4}$ "	cvd

1x2 teeth

Mini-Adson  
Dissecting Forceps



REF #	SIZE cm	SIZE in	SHAPE
CO-0692	12.0 cm	4 $\frac{3}{4}$ "	str
CO-0693	15.0 cm	6"	str

Micro-Adson  
Dressing Forceps



REF #	SIZE cm	SIZE in	SHAPE
CO-0694	12.0 cm	4 $\frac{3}{4}$ "	str
CO-0695	15.0 cm	6"	str

1x2 teeth

Micro-Adson  
Dissecting Forceps

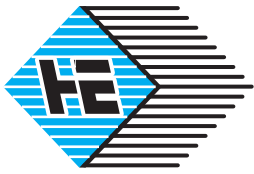

**GENERAL INSTRUMENTS**  
**FORCEPS**  
 Dissecting Forceps, Jeweler Type Forceps



REF # SIZE cm SIZE in SHAPE  
 CO-0696 10.5 cm 4" str

1x2 teeth

Standard  
 Dissecting Forceps (very fine teeth)



REF # SIZE cm SIZE in SHAPE  
 CO-0697 12.0 cm 4 3/4" cvd

Standard  
 Jeweler Type Forceps



REF # SIZE cm SIZE in SHAPE  
 CO-0698 12.0 cm 4 3/4" str

Standard  
 Jeweler Type Forceps



REF # SIZE cm SIZE in SHAPE  
 CO-0699 12.0 cm 4 3/4" str

Standard  
 Jeweler Type Forceps



REF # SIZE cm SIZE in SHAPE  
 CO-0700 11.0 cm 4 1/4" str

Standard  
 Jeweler Type Forceps



REF # SIZE cm SIZE in SHAPE  
 CO-0701 11.0 cm 4 1/4" str

Standard  
 Jeweler Type Forceps



REF # SIZE cm SIZE in SHAPE  
 CO-0702 15.0 cm 6" str  
 CO-0703 18.0 cm 7" str  
 CO-0704 20.0 cm 8" str  
 CO-0705 23.0 cm 9" str  
 CO-0706 25.5 cm 10" str

Russ. Modell  
 Dissecting Forceps



REF # SIZE cm SIZE in SHAPE  
 CO-0707 14.5 cm 5 3/4" str  
 CO-0708 16.0 cm 6 1/4" str  
 CO-0709 20.5 cm 8" str

Durante  
 Dissecting Forceps



REF # SIZE cm SIZE in SHAPE  
 CO-0710 18.0 cm 7" str

Stille-Barraya  
 Dissecting Forceps



## GENERAL INSTRUMENTS

### FORCEPS

Dissecting Forceps, Tubal Forceps, Delicate Pattern,  
Micro Dressing & Dissecting Forceps, Splinter Forceps



REF #	SIZE cm	SIZE in	SHAPE
CO-0711	17.5 cm	7"	str

1x2 teeth

**Bonney**  
Dissecting Forceps



REF #	SIZE cm	SIZE in	SHAPE
CO-0712	23.0 cm	9"	str

**Mayo**  
Dissecting Forceps



REF #	SIZE cm	SIZE in	SHAPE
CO-0713	18.0 cm	7"	str
CO-0714	23.0 cm	9"	str

**Singley-Tuttle**  
Dissecting Forceps



REF #	SIZE cm	SIZE in	SHAPE
CO-0715	23.0 cm	9"	str

**Nelson**  
Dissecting Forceps



REF #	SIZE cm	SIZE in	SHAPE
CO-0716	18.5 cm	7 1/4"	str

**Hepp-Scheidel**  
Tubal Forceps



REF #	SIZE cm	SIZE in	SHAPE
CO-0717	10.0 cm	4"	Fig.1
CO-0718	10.0 cm	4"	Fig.2
CO-0719	09.5 cm	3 3/4"	Fig.3

Dressing Forceps

CO-0720	10.0 cm	4"	Fig.1
CO-0721	10.0 cm	4"	Fig.2
CO-0722	09.5 cm	3 3/4"	Fig.3

Dissecting Forceps (1x2 teeth)



str  
Fig.1



semi-cvd  
Fig.2



cvd  
Fig.3

**Standard**  
delicate pattern



REF #	SIZE cm	SIZE in	SHAPE
CO-0723	15.0 cm	6"	str
CO-0724	18.0 cm	7"	str
CO-0725	15.0 cm	6"	cvd
CO-0726	18.0 cm	7"	cvd

tip 6.0 x 0.4 mm

CO-0727	15.0 cm	6"	str
CO-0728	18.0 cm	7"	str
CO-0729	21.0 cm	8 1/4"	str
CO-0730	23.0 cm	9"	str
CO-0731	15.0 cm	6"	cvd
CO-0732	18.0 cm	7"	cvd
CO-0733	21.0 cm	8 1/4"	cvd
CO-0734	23.0 cm	9"	cvd

tip 6.0 x 0.7 mm

**Standard**  
Micro Dressing Forceps



REF #	SIZE cm	SIZE in	SHAPE
CO-0735	15.0 cm	6"	str
CO-0736	18.0 cm	7"	str
CO-0737	15.0 cm	6"	cvd
CO-0738	18.0 cm	7"	cvd

tip 6.0 x 0.4 mm  
1x2 teeth

CO-0739	15.0 cm	6"	str
CO-0740	18.0 cm	7"	str
CO-0741	21.0 cm	8 1/4"	str
CO-0742	23.0 cm	9"	str
CO-0743	15.0 cm	6"	cvd
CO-0744	18.0 cm	7"	cvd
CO-0745	21.0 cm	8 1/4"	cvd
CO-0746	23.0 cm	9"	cvd

tip 6.0 x 0.7 mm  
1x2 teeth

**Standard**  
Micro Dissecting Forceps



REF #	SIZE cm	SIZE in	SHAPE
CO-0747	12.5 cm	5"	str

**Standard**  
Splinter Forceps (smooth jaw)

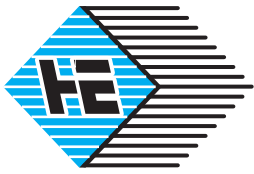

## GENERAL INSTRUMENTS

### FORCEPS

Splinter Forceps, Micro Tying Forceps, Microscopic Forceps



REF #	SIZE cm	SIZE in	SHAPE
CO-0748	12.5 cm	5"	cvd

Standard Splinter Forceps (smooth jaw)



REF #	SIZE cm	SIZE in	SHAPE
CO-0749	12.5 cm	5"	str

Standard Splinter Forceps (serrated jaw)



REF #	SIZE cm	SIZE in	SHAPE
CO-0750	12.5 cm	5"	cvd

Standard Splinter Forceps (serrated jaw)



REF #	SIZE cm	SIZE in	SHAPE
CO-0751	15.5 cm	6"	bayonet

Standard Micro Tying Forceps (smooth jaw)



REF #	SIZE cm	SIZE in	SHAPE
CO-0752	07.5 cm	3"	str
CO-0753	09.0 cm	3½"	str
CO-0754	11.5 cm	4½"	str

Feilchenfeld Splinter Forceps



REF #	SIZE cm	SIZE in	SHAPE
CO-0755	10.5 cm	4"	str
CO-0756	10.5 cm	4"	cvd

Hunter Splinter Forceps



REF #	SIZE cm	SIZE in	SHAPE
CO-0757	10.0 cm	4"	cvd

Standard Microscopic Forceps (super light, blunt)



REF #	SIZE cm	SIZE in	SHAPE
CO-0758	10.0 cm	4"	cvd

Standard Microscopic Forceps (super light, pointed)



REF #	SIZE cm	SIZE in	SHAPE
CO-0759	09.5 cm	3¾"	cvd

Shaaf Splinter Forceps

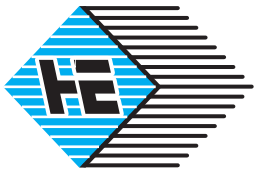

## GENERAL INSTRUMENTS

### FORCEPS

Celia Forceps, Splinter Forceps



REF #	SIZE cm	SIZE in	SHAPE
CO-0760	08.5 cm	3 1/4"	str

Littauer  
Celia Forceps (smooth jaw)



REF #	SIZE cm	SIZE in	SHAPE
CO-0761	08.5 cm	3 1/4"	str

Standard  
Celia Forceps



REF #	SIZE cm	SIZE in	SHAPE
CO-0762	09.0 cm	3 1/2"	str

Douglas  
Celia Forceps



REF #	SIZE cm	SIZE in	SHAPE
CO-0763	09.0 cm	3 1/2"	str

Douglas  
Celia Forceps



REF #	SIZE cm	SIZE in	SHAPE
CO-0764	09.0 cm	3 1/2"	str

Beer  
Celia Forceps (smooth jaw)



REF #	SIZE cm	SIZE in	SHAPE
CO-0765	10.5 cm	4"	cvd

Barraquer  
Celia Forceps (smooth jaw)



REF #	SIZE cm	SIZE in	SHAPE
CO-0766	14.0 cm	5 1/2"	str
CO-0767	13.5 cm	5 1/4"	cvd

Stieglitz  
Splinter Forceps



REF #	SIZE cm	SIZE in	SHAPE
CO-0768	12.5 cm	5"	cvd

Peet  
Splinter Forceps



REF #	SIZE cm	SIZE in	SHAPE
CO-0769	15.0 cm	6"	str
CO-0770	15.0 cm	6"	cvd

Ralk  
Splinter Forceps



**GENERAL INSTRUMENTS**

**FORCEPS**  
Dissecting Forceps, Dressing Forceps

**Tungsten Carbide  
Inserted (TC)**



REF #	SIZE cm	SIZE in	SHAPE
CO-0771	17.5 cm	7"	str

1x2 teeth

**Bonney**  
Dissecting Forceps (normal profile)



REF #	SIZE cm	SIZE in	SHAPE
CO-0772	17.5 cm	7"	str

1x2 teeth

**Gerald**  
Dissecting Forceps (mini profile)



REF #	SIZE cm	SIZE in	SHAPE
CO-0773	15.5 cm	6"	str

1x2 teeth

**Gillies**  
Dissecting Forceps (mini profile)



REF #	SIZE cm	SIZE in	SHAPE
CO-0774	15.0 cm	6"	str

**McIndoe**  
Dressing Forceps (mini profile)



REF #	SIZE cm	SIZE in	SHAPE
CO-0775	12.0 cm	4 3/4"	str

7x7 teeth

**Adson-Brown**  
Dissecting Forceps (normal profile)



REF #	SIZE cm	SIZE in	SHAPE
CO-0776	12.0 cm	4 3/4"	str
CO-0777	15.0 cm	6"	str

1x2 teeth

**Adson**  
Dissecting Forceps (mini profile)



REF #	SIZE cm	SIZE in	SHAPE
CO-0778	12.0 cm	4 3/4"	str
CO-0779	15.0 cm	6"	str

**Adson**  
Dressing Forceps (normal profile)



REF #	SIZE cm	SIZE in	SHAPE
CO-0780	12.0 cm	4 3/4"	str
CO-0781	15.0 cm	6"	str

1x2 teeth

**Adson**  
Dressing Forceps (normal profile)



REF #	SIZE cm	SIZE in	SHAPE
CO-0782	17.5 cm	7"	str

**Cushing**  
Dressing Forceps (normal profile)



## GENERAL INSTRUMENTS

### FORCEPS

Haemostatic Forceps, Organ Grasping Forceps,  
Tumor Grasping Forceps



**Pean**  
Haemostatic Forceps

REF #	SIZE cm	SIZE in	SHAPE
DO-0855	14.5 cm	5 3/4"	str
DO-0856	16.0 cm	6 1/4"	str



**Spencer-Wells**  
Haemostatic Forceps

REF #	SIZE cm	SIZE in	SHAPE
DO-0857	13.0 cm	5"	str
DO-0858	14.0 cm	5 1/2"	str
DO-0859	15.5 cm	6"	str
DO-0860	18.5 cm	7 1/4"	str
DO-0861	20.0 cm	8"	str

REF #	SIZE cm	SIZE in	SHAPE
DO-0862	13.0 cm	5"	cvd
DO-0863	14.0 cm	5 1/2"	cvd
DO-0864	15.5 cm	6"	cvd
DO-0865	18.5 cm	7 1/4"	cvd
DO-0866	20.0 cm	8"	cvd

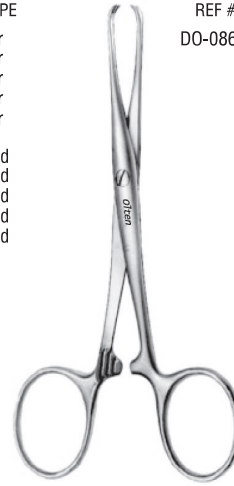

**Chaput**  
Haemostatic Forceps

REF #	SIZE cm	SIZE in	SHAPE
DO-0867	12.5 cm	5"	str

2:3 teeth



**Tuffier**  
Haemostatic Forceps

REF #	SIZE cm	SIZE in	SHAPE
DO-0868	12.5 cm	5"	str

4:5 teeth



**Standard**  
Organ Grasping Forceps

REF #	SIZE cm	SIZE in	SHAPE
DO-0869	25.0 cm	9 3/4"	str
DO-0870	26.0 cm	10 1/4"	str



**Collin**  
Organ Grasping Forceps

REF #	SIZE cm	SIZE in	SHAPE
DO-0871	14.0 cm	5 1/2"	str



**Collin**  
Tumor Grasping Forceps

REF #	SIZE cm	SIZE in	SHAPE
DO-0872	17.0 cm	6 3/4"	str



**Pennington**  
Haemostatic Forceps

REF #	SIZE cm	SIZE in	SHAPE
DO-0873	15.5 cm	6"	str
DO-0874	21.0 cm	8 1/4"	str



**Pratt**  
Haemostatic Forceps

REF #	SIZE cm	SIZE in	SHAPE
DO-0875	15.0 cm	6"	str

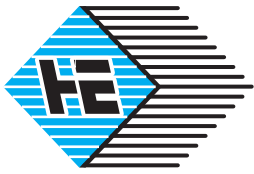

## GENERAL INSTRUMENTS

### FORCEPS

Face-Lift Forceps, Ligature Forceps, Dissecting Forceps, Haemostatic Forceps



**Standard**  
Ligature Forceps (smooth jaw)

REF #	SIZE cm	SIZE in	SHAPE
DO-0876	12.5 cm	5"	str



**Mixer-Baby**  
Dissecting Forceps

REF #	SIZE cm	SIZE in	SHAPE
DO-0877	13.5 cm	5¼"	Fig.1



**Standard**  
Ligature Forceps  
cross serrated jaw

REF #	SIZE cm	SIZE in	SHAPE
DO-0878	12.5 cm	5"	cvd



**Haemostatic**  
Forceps

REF #	SIZE cm	SIZE in	SHAPE
DO-0879	10.0 cm	4"	str
DO-0880	10.0 cm	4"	cvd



**Martel-Rees**  
Face-lift Forceps

REF #	SIZE cm	SIZE in	SHAPE
DO-0881	13.5 cm	5¼"	str



**Halsted-Mosquito**  
Haemostatic Forceps

REF #	SIZE cm	SIZE in	SHAPE
DO-0882	10.0 cm	4"	str
DO-0883	11.5 cm	4½"	str
DO-0884	12.5 cm	5"	str
DO-0885	14.5 cm	5½"	str
DO-0886	10.0 cm	4"	cvd
DO-0887	11.5 cm	4½"	cvd
DO-0888	12.5 cm	5"	cvd
DO-0889	14.5 cm	5½"	cvd

With out teeth

DO-0890	10.0 cm	4"	str
DO-0891	11.5 cm	4½"	str
DO-0892	12.5 cm	5"	str
DO-0893	14.5 cm	5½"	str
DO-0894	10.0 cm	4"	cvd
DO-0895	11.5 cm	4½"	cvd
DO-0896	12.5 cm	5"	cvd
DO-0897	14.5 cm	5½"	cvd

1x2 teeth

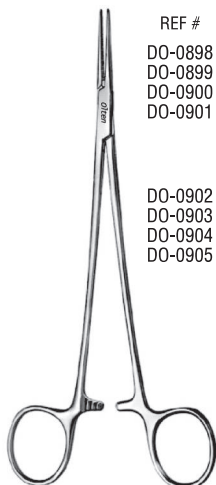

**Halsted-Mosquito**  
Haemostatic Forceps

REF #	SIZE cm	SIZE in	SHAPE
DO-0898	18.0 cm	7"	str
DO-0899	21.0 cm	8½"	str
DO-0900	18.0 cm	7"	cvd
DO-0901	21.0 cm	8½"	cvd

With out teeth

DO-0902	18.0 cm	7"	str
DO-0903	21.0 cm	8½"	str
DO-0904	18.0 cm	7"	cvd
DO-0905	21.0 cm	8½"	cvd

1x2 teeth

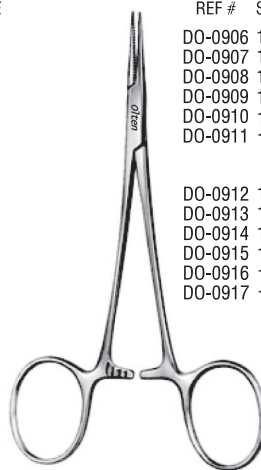

**Micro-Mosquito**  
Haemostatic Forceps

REF #	SIZE cm	SIZE in	SHAPE
DO-0906	10.0 cm	4"	str
DO-0907	11.5 cm	4½"	str
DO-0908	12.5 cm	5"	str
DO-0909	10.0 cm	4"	cvd
DO-0910	11.5 cm	4½"	cvd
DO-0911	12.5 cm	5"	cvd

With out teeth

DO-0912	10.0 cm	4"	str
DO-0913	11.5 cm	4½"	str
DO-0914	12.5 cm	5"	str
DO-0915	10.0 cm	4"	cvd
DO-0916	11.5 cm	4½"	cvd
DO-0917	12.5 cm	5"	cvd

1x2 teeth



**Providence-Hospital**  
Haemostatic Forceps

REF #	SIZE cm	SIZE in	SHAPE
DO-0918	14.0 cm	5½"	str
DO-0919	14.0 cm	5½"	cvd



## GENERAL INSTRUMENTS

### FORCEPS Haemostatic Forceps,



Leriche  
Haemostatic Forceps

REF #	SIZE cm	SIZE in	SHAPE
DO-0920	15.0 cm	6"	str
DO-0921	15.0 cm	6"	cvd
With out teeth			
DO-0922	15.0 cm	6"	str
DO-0923	15.0 cm	6"	cvd
1x2 teeth			

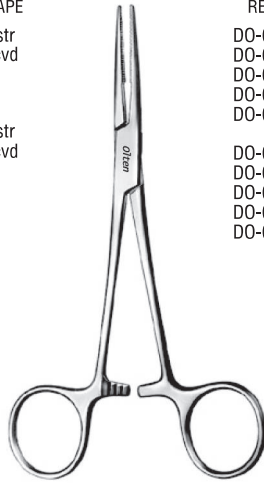

Kelly  
Haemostatic Forceps

REF #	SIZE cm	SIZE in	SHAPE
DO-0924	14.5 cm	5½"	str
DO-0925	16.0 cm	6¼"	str
DO-0926	18.0 cm	7"	str
DO-0927	19.0 cm	7½"	str
DO-0928	20.5 cm	8"	str
DO-0929	14.0 cm	5½"	cvd
DO-0930	16.0 cm	6¼"	cvd
DO-0931	18.0 cm	7"	cvd
DO-0932	19.0 cm	7½"	cvd
DO-0933	20.5 cm	8"	cvd

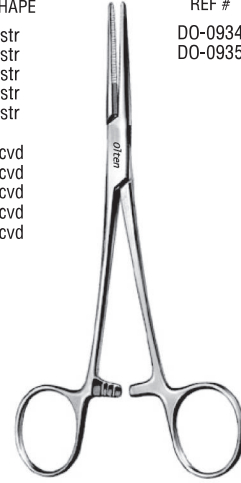

Kelly-Rankin  
Haemostatic Forceps

REF #	SIZE cm	SIZE in	SHAPE
DO-0934	16.0 cm	6¼"	str
DO-0935	16.0 cm	6¼"	cvd



Overholt-Baby  
Haemostatic Forceps

REF #	SIZE cm	SIZE in	SHAPE
DO-0936	14.0 cm	5½"	cvd



Crile  
Haemostatic Forceps

REF #	SIZE cm	SIZE in	SHAPE
DO-0937	14.0 cm	5½"	str
DO-0938	14.0 cm	5½"	cvd
With out teeth			
DO-0939	14.0 cm	5½"	str
DO-0940	14.0 cm	5½"	cvd
1x2 teeth			



Crile-Rankin  
Haemostatic Forceps

REF #	SIZE cm	SIZE in	SHAPE
DO-0941	16.0 cm	6¼"	str
DO-0942	16.0 cm	6¼"	cvd



Lovelace  
Haemostatic Forceps (cross serrated)

REF #	SIZE cm	SIZE in	SHAPE
DO-0943	16.0 cm	6¼"	str
With out teeth			
DO-0944	16.0 cm	6¼"	str
1x2 teeth			



Dandy-Mosquito  
Haemostatic Forceps

REF #	SIZE cm	SIZE in	SHAPE
DO-0945	12.0 cm	4¾"	laterally curved



Dandy  
Haemostatic Forceps

REF #	SIZE cm	SIZE in	SHAPE
DO-0946	14.0 cm	5½"	laterally curved
With out teeth			
DO-0947	14.0 cm	5½"	laterally curved
1x2 teeth			



## GENERAL INSTRUMENTS

### FORCEPS

Dissecting & Ligature Forceps, Haemostatic Forceps



REF #	SIZE cm	SIZE in	SHAPE
DO-0948	19.0 cm	7½"	Fig.1
DO-0949	19.0 cm	7½"	Fig.2
DO-0950	19.0 cm	7½"	Fig.3

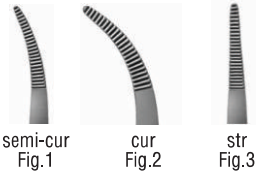

**Schnidt**  
Dissecting and Ligature Forceps



REF #	SIZE cm	SIZE in	SHAPE
DO-0951	19.0 cm	7½"	str
DO-0952	18.5 cm	7¼"	cvd

**Adson**  
Dissecting and Ligature Forceps



REF #	SIZE cm	SIZE in	SHAPE
DO-0953	20.5 cm	8"	cvd

Dissecting and Ligature Forceps



REF #	SIZE cm	SIZE in	SHAPE
DO-0954	16.0 cm	6¼"	str
DO-0955	20.0 cm	8"	str
DO-0956	16.0 cm	6¼"	cvd
DO-0957	20.0 cm	8"	cvd



**Rochester-Carmalt**  
Haemostatic Forceps



REF #	SIZE cm	SIZE in	SHAPE
DO-0958	13.0 cm	5"	str
DO-0959	14.0 cm	5½"	str
DO-0960	16.0 cm	6¼"	str
DO-0961	13.0 cm	5"	cvd
DO-0962	14.0 cm	5½"	cvd
DO-0963	16.0 cm	6¼"	cvd

**Pean**  
Haemostatic Forceps



REF #	SIZE cm	SIZE in	SHAPE
DO-0964	13.0 cm	5"	str
DO-0965	14.0 cm	5½"	str
DO-0966	16.0 cm	6¼"	str
DO-0967	13.0 cm	5"	cvd
DO-0968	14.0 cm	5½"	cvd
DO-0969	16.0 cm	6¼"	cvd

1x2 teeth

**Kocher**  
Haemostatic Forceps



REF #	SIZE cm	SIZE in	SHAPE
DO-0970	14.5 cm	5¾"	str
DO-0971	16.0 cm	6¼"	str
DO-0972	18.0 cm	7"	str
DO-0973	14.5 cm	5¾"	cvd
DO-0974	16.0 cm	6¼"	cvd
DO-0975	18.0 cm	7"	cvd

**Pean-Nippon**  
Haemostatic Forceps



REF #	SIZE cm	SIZE in	SHAPE
DO-0976	14.5 cm	5¾"	str
DO-0977	16.0 cm	6¼"	str
DO-0978	18.0 cm	7"	str
DO-0979	14.5 cm	5¾"	cvd
DO-0980	16.0 cm	6¼"	cvd
DO-0981	18.0 cm	7"	cvd

1x2 teeth

**Kocher-Nippon**  
Haemostatic Forceps



REF #	SIZE cm	SIZE in	SHAPE
DO-0982	20.0 cm	8"	str
DO-0983	26.0 cm	10¼"	str
DO-0984	20.0 cm	8"	cvd
DO-0985	26.0 cm	10¼"	cvd

With out teeth

DO-0986	20.0 cm	8"	str
DO-0987	26.0 cm	10¼"	str
DO-0988	20.0 cm	8"	cvd
DO-0989	26.0 cm	10¼"	cvd

1x2 teeth

**Bengolea**  
Haemostatic Forceps

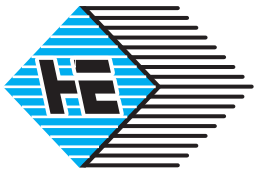

## GENERAL INSTRUMENTS

### FORCEPS

Haemostatic Forceps, Dissecting & Ligature Forceps



REF #	SIZE cm	SIZE in	SHAPE
DO-0990	14.0 cm	5½"	str
DO-0991	16.0 cm	6¼"	str
DO-0992	18.0 cm	7"	str
DO-0993	20.0 cm	8"	str
DO-0994	22.0 cm	8¾"	str
DO-0995	24.0 cm	9½"	str
DO-0996	26.0 cm	10¼"	str
DO-0997	30.0 cm	12"	str
DO-0998	14.0 cm	5½"	cvd
DO-0999	16.0 cm	6¼"	cvd
DO-1000	18.0 cm	7"	cvd
DO-1001	20.0 cm	8"	cvd
DO-1002	22.0 cm	8¾"	cvd
DO-1003	24.0 cm	9½"	cvd
DO-1004	26.0 cm	10¼"	cvd
DO-1005	30.0 cm	12"	cvd

**Pean (Rochester)**  
Haemostatic Forceps



REF #	SIZE cm	SIZE in	SHAPE
DO-1006	14.0 cm	5½"	str
DO-1007	16.0 cm	6¼"	str
DO-1008	18.0 cm	7"	str
DO-1009	20.0 cm	8"	str
DO-1010	22.0 cm	8¾"	str
DO-1011	24.0 cm	9½"	str
DO-1012	26.0 cm	10¼"	str
DO-1013	30.0 cm	12"	str
DO-1014	14.0 cm	5½"	cvd
DO-1015	16.0 cm	6¼"	cvd
DO-1016	18.0 cm	7"	cvd
DO-1017	20.0 cm	8"	cvd
DO-1018	22.0 cm	8¾"	cvd
DO-1019	24.0 cm	9½"	cvd
DO-1020	26.0 cm	10¼"	cvd
DO-1021	30.0 cm	12"	cvd

1x2 teeth

**Kocher (Ochsner)**  
Haemostatic Forceps



REF #	SIZE cm	SIZE in	SHAPE
DO-1022	18.5 cm	7¼"	cvd

**Mixer-Baby**  
Dissecting and Ligature Forceps



REF #	SIZE cm	SIZE in	SHAPE
DO-1023	18.5 cm	7¼"	cvd

**Mixer-Baby**  
Dissecting and Ligature Forceps



REF #	SIZE cm	SIZE in	SHAPE
DO-1024	14.5 cm	5¾"	cvd
DO-1025	18.0 cm	7"	cvd



cvd  
Fig.1



cvd  
Fig.2

**Adson-Baby**  
Dissecting and Ligature Forceps



REF #	SIZE cm	SIZE in	SHAPE
DO-1026	20.0 cm	8"	Fig.1
DO-1027	20.0 cm	8"	Fig.2
DO-1028	20.0 cm	8"	Fig.3



str  
Fig.1



semi-cvd  
Fig.2



cvd  
Fig.3

**Heiss**  
Dissecting and Ligature Forceps



REF #	SIZE cm	SIZE in	SHAPE
DO-1029	21.5 cm	8½"	cvd

**Overholt-Mixer**  
Dissecting and Ligature Forceps



REF #	SIZE cm	SIZE in
DO-1030	14.0 cm	5½"
DO-1031	18.0 cm	7¼"
DO-1032	20.0 cm	8"
DO-1033	23.0 cm	9"



**Mixer**  
Dissecting and Ligature Forceps



REF #	SIZE cm	SIZE in	SHAPE
DO-1034	24.0 cm	9½"	str
DO-1035	24.0 cm	9½"	cvd

**Sarot**  
Dissecting and Ligature Forceps



## GENERAL INSTRUMENTS

### FORCEPS

Haemostatic Forceps, Dissecting & Ligature Forceps



Overholt-Geissendorfer  
Haemostatic Forceps

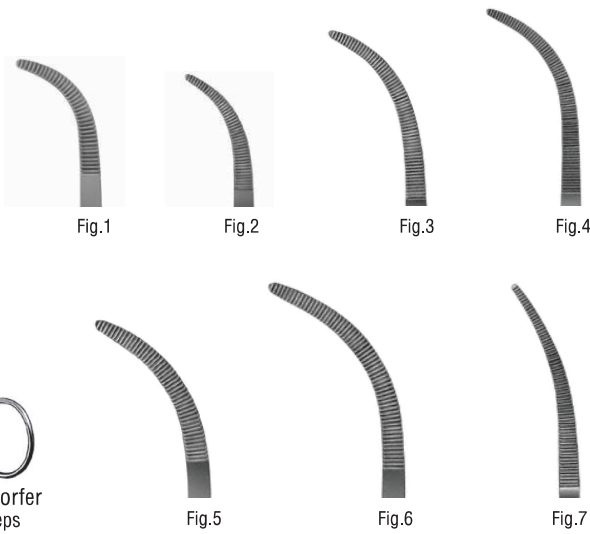

REF #	SIZE cm	SIZE in	SHAPE
DO-1036	21.0 cm	8 1/4"	Fig.1
DO-1037	21.0 cm	8 1/4"	Fig.2
DO-1038	21.0 cm	8 1/4"	Fig.3
DO-1039	21.0 cm	8 1/4"	Fig.4
DO-1040	21.0 cm	8 1/4"	Fig.5
DO-1041	21.0 cm	8 1/4"	Fig.6
DO-1042	21.0 cm	8 1/4"	Fig.7
DO-1043	27.0 cm	10 3/4"	Fig.1
DO-1044	27.0 cm	10 3/4"	Fig.2
DO-1045	27.0 cm	10 3/4"	Fig.3
DO-1046	27.0 cm	10 3/4"	Fig.4
DO-1047	27.0 cm	10 3/4"	Fig.5
DO-1048	27.0 cm	10 3/4"	Fig.6
DO-1049	27.0 cm	10 3/4"	Fig.7



Crafoord  
Dissecting and Ligature Forceps

REF #	SIZE cm	SIZE in	SHAPE
DO-1050	18.0 cm	7"	cvd
DO-1051	24.5 cm	9 3/4"	cvd



Overholt-Fino  
Dissecting and Ligature Forceps

REF #	SIZE cm	SIZE in	SHAPE
DO-1052	21.5 cm	8 1/2"	Fig.0
DO-1053	21.0 cm	8 1/4"	Fig.1
DO-1054	22.0 cm	8 1/2"	Fig.2
DO-1055	23.0 cm	9"	Fig.3
DO-1056	22.5 cm	8 3/4"	Fig.4

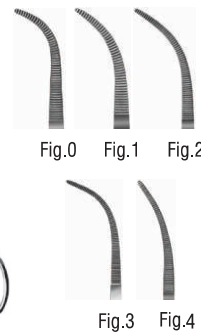

Gemini  
Dissecting and Ligature Forceps

REF #	SIZE cm	SIZE in	SHAPE
DO-1057	13.0 cm	5"	cvd
DO-1058	16.0 cm	6 1/4"	cvd
DO-1059	18.0 cm	7"	cvd
DO-1060	21.0 cm	8 1/4"	cvd
DO-1061	23.0 cm	9"	cvd
DO-1062	25.0 cm	9 3/4"	cvd
DO-1063	28.0 cm	11"	cvd



Overholt  
Dissecting and Ligature Forceps

REF #	SIZE cm	SIZE in	SHAPE
DO-1064	29.5 cm	11 1/2"	Fig.0
DO-1065	29.5 cm	11 1/2"	Fig.1
DO-1066	30.0 cm	11 3/4"	Fig.2

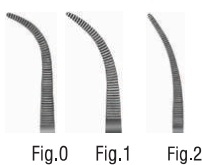

Gross-Maier  
Dissecting and Ligature Forceps

REF #	SIZE cm	SIZE in	SHAPE
DO-1067	22.0 cm	8 3/4"	str
DO-1068	22.0 cm	8 3/4"	cvd



Mini-Gimini  
Dissecting and Ligature Forceps

REF #	SIZE cm	SIZE in	SHAPE
DO-1069	18.0 cm	7"	cvd
DO-1070	22.5 cm	8 3/4"	cvd
DO-1071	25.0 cm	9 3/4"	cvd
DO-1072	28.5 cm	11 1/4"	cvd

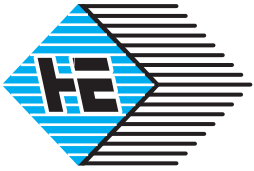

**GENERAL INSTRUMENTS**  
**FORCEPS**  
 Dissecting & Ligature Forceps



REF #	SIZE cm	SIZE in	SHAPE
DO-1073	21.0 cm	8¼"	cvd

**Wickstrom**  
 Dissecting and Ligature Forceps



REF #	SIZE cm	SIZE in	SHAPE
DO-1074	24.0 cm	9½"	Fig.1
DO-1075	23.5 cm	9¼"	Fig.2
DO-1076	23.0 cm	9"	Fig.3
DO-1077	24.0 cm	9½"	Fig.4
DO-1078	23.5 cm	9¼"	Fig.5

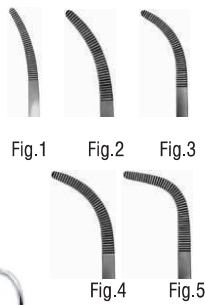

**Rumel**  
 Dissecting and Ligature Forceps



REF #	SIZE cm	SIZE in	SHAPE
DO-1079	29.5 cm	11½"	Fig.1
DO-1080	28.5 cm	11¼"	Fig.2



**Zenker**  
 Dissecting and Ligature Forceps



REF #	SIZE cm	SIZE in	SHAPE
DO-1081	13.5 cm	5¼"	cvd

**Mixer-Baby**  
 Dissecting and Ligature Forceps



REF #	SIZE cm	SIZE in	SHAPE
DO-1082	16.0 cm	6¼"	cvd
DO-1083	18.0 cm	7"	cvd

**Mixer**  
 Dissecting and Ligature Forceps



REF #	SIZE cm	SIZE in	SHAPE
DO-1084	18.0 cm	7"	cvd

**Mixer-O'Shaughnessy**  
 Dissecting and Ligature Forceps



REF #	SIZE cm	SIZE in	SHAPE
DO-1085	22.5 cm	8¾"	cvd

**Mixer**  
 Dissecting and Ligature Forceps



REF #	SIZE cm	SIZE in	SHAPE
DO-1086	23.0 cm	9"	cvd

**Mixer**  
 Dissecting and Ligature Forceps



REF #	SIZE cm	SIZE in	SHAPE
DO-1087	22.5 cm	8¾"	cvd
DO-1088	26.0 cm	10¼"	cvd
DO-1089	28.0 cm	11"	cvd

**Mixer**  
 Dissecting and Ligature Forceps



## GENERAL INSTRUMENTS

### FORCEPS

Dissecting & Ligature Forceps, Bile Duct Clamp,  
Tangential Forceps, Kidney Pedicle Clamp



REF #	SIZE cm	SIZE in	SHAPE
DO-1090	23.5 cm	9 1/4"	cvd

**Mc Quigg-Mixter**  
Dissecting and Ligature Forceps



REF #	SIZE cm	SIZE in	SHAPE
DO-1091	18.5 cm	7 1/4"	cvd

**Lower**  
Dissecting and Ligature Forceps



REF #	SIZE cm	SIZE in	SHAPE
DO-1092	24.0 cm	9 1/2"	cvd

**Finochietto**  
Dissecting and Ligature Forceps



REF #	SIZE cm	SIZE in	SHAPE
DO-1093	19.5 cm	7 3/4"	cvd
DO-1094	22.5 cm	8 3/4"	cvd

**Lahey**  
Duct Clamp



REF #	SIZE cm	SIZE in	SHAPE
DO-1095	21.0 cm	8 1/4"	cvd

**Desjardins**  
Duct Clamp



REF #	SIZE cm	SIZE in	SHAPE
DO-1096	25.0 cm	9 3/4"	
DO-1097	27.0 cm	10 3/4"	

**Gall**  
**Uro-Tangential**  
Tangential Forceps



REF #	SIZE cm	SIZE in	SHAPE
DO-1098	23.0 cm	9"	cvd
DO-1099	24.0 cm	9 1/2"	cvd

**Guyon**  
Kidney Pedicle Clamp



REF #	SIZE cm	SIZE in	SHAPE
DO-1100	19.5 cm	7 3/4"	cvd
DO-1101	21.5 cm	8 1/2"	cvd
DO-1102	24.0 cm	9 1/2"	cvd

**Guyon**  
Kidney Pedicle Clamp



REF #	SIZE cm	SIZE in	SHAPE
DO-1103	24.0 cm	9 1/2"	cvd

**Guyon**  
Kidney Pedicle Clamp

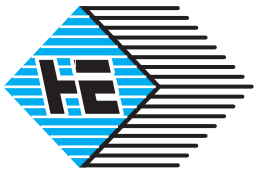

## GENERAL INSTRUMENTS

### FORCEPS

Dissecting & Ligature Forceps, Haemostatic Forceps  
Hysterectomy Forceps, Vaginal Clamp



REF #	SIZE cm	SIZE in	SHAPE
DO-1104	28.0 cm	11"	cvd

**Lawrence**  
Dissecting and Ligature Forceps



**Kelly**  
Dissecting and Ligature Forceps

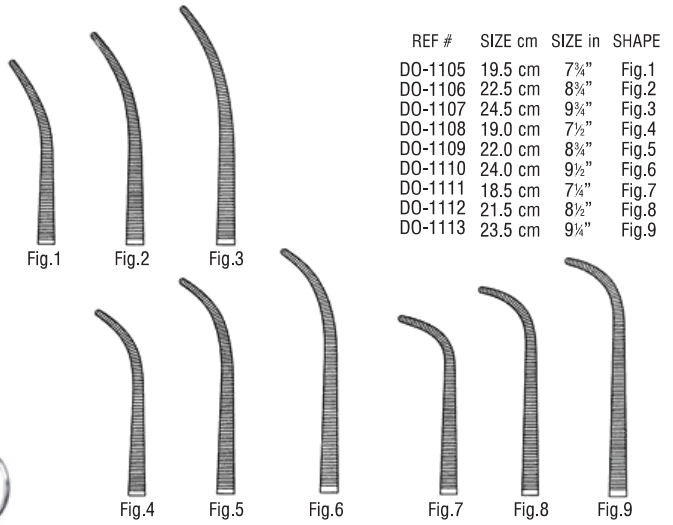

REF #	SIZE cm	SIZE in	SHAPE
DO-1105	19.5 cm	7 $\frac{3}{4}$ "	Fig.1
DO-1106	22.5 cm	8 $\frac{3}{4}$ "	Fig.2
DO-1107	24.5 cm	9 $\frac{3}{4}$ "	Fig.3
DO-1108	19.0 cm	7 $\frac{1}{2}$ "	Fig.4
DO-1109	22.0 cm	8 $\frac{3}{4}$ "	Fig.5
DO-1110	24.0 cm	9 $\frac{1}{2}$ "	Fig.6
DO-1111	18.5 cm	7 $\frac{1}{4}$ "	Fig.7
DO-1112	21.5 cm	8 $\frac{1}{2}$ "	Fig.8
DO-1113	23.5 cm	9 $\frac{1}{4}$ "	Fig.9



**Roberts**  
Dissecting and Ligature Forceps

REF #	SIZE cm	SIZE in	SHAPE
DO-1114	22.5 cm	8 $\frac{3}{4}$ "	str
DO-1115	21.5 cm	8 $\frac{1}{2}$ "	cvd



**Meeker**  
Dissecting and Ligature Forceps

REF #	SIZE cm	SIZE in	SHAPE
DO-1116	28.0 cm	11"	cvd



**Negus**  
Haemostatic Forceps

REF #	SIZE cm	SIZE in	SHAPE
DO-1117	19.5 cm	7 $\frac{3}{4}$ "	Fig.1
DO-1118	20.0 cm	8"	Fig.2

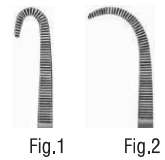

**Phaneuf**  
Hysterectomy Forceps

REF #	SIZE cm	SIZE in	SHAPE
DO-1119	20.5 cm	8"	str
DO-1120	20.0 cm	8"	60° angled

1x2 teeth



**Heaney**  
Hysterectomy Forceps

REF #	SIZE cm	SIZE in	SHAPE
DO-1121	19.5 cm	7 $\frac{3}{4}$ "	Fig.1
DO-1122	21.5 cm	8 $\frac{1}{2}$ "	Fig.1
DO-1123	24.0 cm	9 $\frac{1}{2}$ "	Fig.1
DO-1124	19.5 cm	7 $\frac{3}{4}$ "	Fig.2
DO-1125	21.5 cm	8 $\frac{1}{2}$ "	Fig.2
DO-1126	24.0 cm	9 $\frac{1}{2}$ "	Fig.2
DO-1127	19.5 cm	7 $\frac{3}{4}$ "	Fig.3
DO-1128	21.5 cm	8 $\frac{1}{2}$ "	Fig.3
DO-1129	24.0 cm	9 $\frac{1}{2}$ "	Fig.3

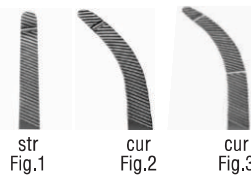

**Wertheim-Cullen**  
Vaginal Clamp

REF #	SIZE cm	SIZE in	SHAPE
DO-1130	21.0 cm	8 $\frac{1}{4}$ "	cvd



# GENERAL INSTRUMENTS

## FORCEPS

### Hysterectomy Forceps, Peritoneum Forceps



**Rogers**  
Hysterectomy Forceps

Fig.1



Fig.2



Fig.3



Fig.4



Fig.5



Fig.6



Fig.7



Fig.8

REF #	SIZE cm	SIZE in	SHAPE
DO-1131	21.5 cm	8½"	Fig.1
DO-1132	21.0 cm	8¼"	Fig.2
DO-1133	20.5 cm	8"	Fig.3
DO-1134	20.0 cm	8"	Fig.4
DO-1135	25.5 cm	10"	Fig.5
DO-1136	25.0 cm	9¾"	Fig.6
DO-1137	24.5 cm	9¾"	Fig.7
DO-1138	23.0 cm	9"	Fig.8



**Moynihan**  
Hysterectomy Forceps

REF #	SIZE cm	SIZE in	SHAPE
DO-1139	23.0 cm	9"	cvd



**Moynihan**  
Hysterectomy Forceps

REF #	SIZE cm	SIZE in	SHAPE
DO-1140	23.5 cm	9¼"	cvd



**Wertheim**  
Hysterectomy Forceps

REF #	SIZE cm	SIZE in	SHAPE
DO-1141	26.0 cm	10¼"	cvd



**Wertheim**  
Hysterectomy Forceps

REF #	SIZE cm	SIZE in	SHAPE
DO-1142	22.5 cm	8¾"	Fig.1
DO-1143	22.5 cm	8¾"	Fig.2



semi-cur  
Fig.1  
1x2 teeth

cur  
Fig.2  
1x2 teeth



**Mikulicz, Baby**  
Peritoneum Forceps

REF #	SIZE cm	SIZE in	SHAPE
DO-1144	14.5 cm	5¾"	cvd

1x2 teeth



**Mikulicz**  
Peritoneum Forceps

REF #	SIZE cm	SIZE in	SHAPE
DO-1145	18.5 cm	7¼"	cvd

1x2 teeth



**Mikulicz**  
Peritoneum Forceps

REF #	SIZE cm	SIZE in	SHAPE
DO-1146	20.0 cm	8"	



**GENERAL INSTRUMENTS**  
**FORCEPS**  
 Peritoneum Forceps, Towel Clamp



REF # SIZE cm SIZE in SHAPE  
 DO-1147 20.0 cm 8" cvd

1x2 teeth

**Mikulicz**  
 Peritoneum Forceps



REF # SIZE cm SIZE in SHAPE  
 DO-1148 20.5 cm 8" cvd

1x2 teeth

**Mikulicz**  
 Peritoneum Forceps



REF # SIZE cm SIZE in SHAPE  
 DO-1149 21.0 cm 8 1/4" Fig.1  
 DO-1150 21.0 cm 8 1/4" Fig.2

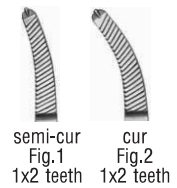

**Faure**  
 Peritoneum Forceps



REF # SIZE cm SIZE in SHAPE  
 DO-1151 09.0 cm 3 1/2" srp-srp

**Schadel**  
 Towel Clamp



REF # SIZE cm SIZE in SHAPE  
 DO-1152 05.5 cm 2 1/4" srp-srp  
 DO-1153 08.5 cm 3 1/4" srp-srp

**Jones**  
 Towel Clamp



REF # SIZE cm SIZE in SHAPE  
 DO-1154 08.5 cm 3 1/4" srp-srp  
 with tube holder

**Jones**  
 Towel Clamp



REF # SIZE cm SIZE in SHAPE  
 DO-1155 11.5 cm 4 1/2" cvd  
 DO-1156 13.0 cm 5" cvd

**Backhaus**  
 Towel Clamp (delicate model)



REF # SIZE cm SIZE in SHAPE  
 DO-1157 11.5 cm 4 1/2" cvd  
 with tube holder

**Backhaus**  
 Towel Clamp



REF # SIZE cm SIZE in SHAPE  
 DO-1158 09.0 cm 3 1/2" cvd  
 DO-1159 10.5 cm 4" cvd  
 DO-1160 11.5 cm 4 1/2" cvd  
 DO-1161 13.0 cm 5 1/8" cvd  
 DO-1162 16.0 cm 6 1/4" cvd

**Backhaus**  
 Towel Clamp



## GENERAL INSTRUMENTS

FORCEPS  
Towel Clamp, Tubing Clamp

**Olten**  
Instruments

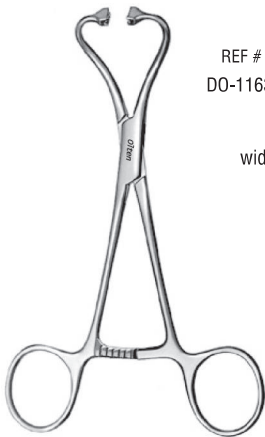

REF #	SIZE cm	SIZE in	SHAPE
DO-1163	15.5 cm	6"	cvd

wide jaw for tube fixation

Peers-Bertram modif.  
Towel Clamp



REF #	SIZE cm	SIZE in	SHAPE
DO-1164	13.5 cm	5 1/4"	cvd

Roder  
Towel Clamp



REF #	SIZE cm	SIZE in	SHAPE
DO-1165	09.5 cm	3 3/4"	cvd
DO-1166	12.5 cm	5"	cvd

Lorna  
Towel Clamp (fine serrated, wide jaw)



REF #	SIZE cm	SIZE in	SHAPE
DO-1167	16.5 cm	6 1/2"	str

Bernhard  
Towel Clamp



REF #	SIZE cm	SIZE in	SHAPE
DO-1168	10.5 cm	4"	cvd
DO-1169	13.5 cm	5 1/4"	cvd
DO-1170	14.5 cm	5 3/4"	cvd

Tohoku  
Towel Clamp

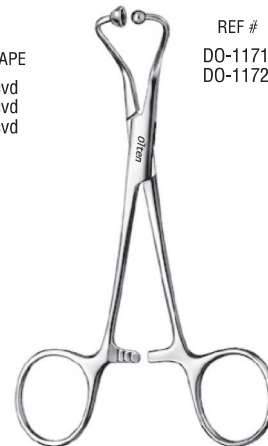

REF #	SIZE cm	SIZE in	SHAPE
DO-1171	11.5 cm	4 1/2"	cvd
DO-1172	14.0 cm	5 1/2"	cvd

Standard  
Towel Clamp (for paper clothes)



REF #	SIZE cm	SIZE in	SHAPE
DO-1173	19.5 cm	7 3/4"	str

Lane  
Towel Clamp



REF #	SIZE cm	SIZE in	SHAPE
DO-1174	14.0 cm	5 1/2"	str

Standard  
Tubing Clamp (extra long ratchet)



REF #	SIZE cm	SIZE in	SHAPE
DO-1175	16.5 cm	6 1/2"	str

Standard  
Tubing Clamp



## GENERAL INSTRUMENTS

### FORCEPS Tubing Clamp

**Olten**  
Instruments



REF #	SIZE cm	SIZE in	SHAPE
DO-1176	15.5 cm	6"	str
DO-1177	19.0 cm	7½"	str
DO-1178	20.5 cm	8"	str



Standard  
Tubing Clamp



REF #	SIZE cm	SIZE in	SHAPE
DO-1179	15.5 cm	6"	str
DO-1180	19.0 cm	7½"	str
DO-1181	20.5 cm	8"	str



Standard  
Tubing Clamp (with safety guard)



REF #	SIZE cm	SIZE in	SHAPE
DO-1182	22.5 cm	8¾"	str
DO-1183	26.5 cm	10½"	str
DO-1184	22.5 cm	8¾"	cvd
DO-1185	26.5 cm	10½"	cvd

Ulrich  
Dressing Forceps



REF #	SIZE cm	SIZE in	SHAPE
DO-1186	17.5 cm	7"	str
DO-1187	17.0 cm	6¾"	cvd

Dressing Forceps

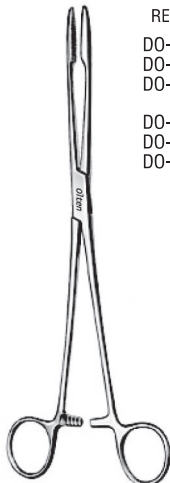

REF #	SIZE cm	SIZE in	SHAPE
DO-1188	20.5 cm	8"	str
DO-1189	22.0 cm	8¾"	str
DO-1190	26.5 cm	10½"	str
DO-1191	20.0 cm	8"	cvd
DO-1192	21.5 cm	8½"	cvd
DO-1193	26.0 cm	10¼"	cvd

Gross-Maier  
Dressing Forceps



REF #	SIZE cm	SIZE in	SHAPE
DO-1194	25.5 cm	10"	str

Collin  
Dressing Forceps



REF #	SIZE cm	SIZE in	SHAPE
DO-1195	23.5 cm	9¼"	str

Cheron  
Dressing Forceps



REF #	SIZE cm	SIZE in	SHAPE
DO-1196	13.0 cm	5"	str
DO-1197	16.0 cm	6¼"	str
DO-1198	18.0 cm	7"	str

Lister  
Sinus Forceps



REF #	SIZE cm	SIZE in	SHAPE
DO-1199	39.5 cm	15½"	cvd

Standard  
Tunneling Forceps



## GENERAL INSTRUMENTS

### FORCEPS Tubing Clamp



REF #	SIZE cm	SIZE in	SHAPE
DO-1200	26.0 cm	10 1/4"	cvd

Bozemann  
Sponge Forceps



REF #	SIZE cm	SIZE in	SHAPE
DO-1201	25.0 cm	9 3/4"	str
DO-1202	24.5 cm	9 3/4"	cvd

Foerster  
Sponge Forceps



REF #	SIZE cm	SIZE in	SHAPE
DO-1203	18.0 cm	7"	str
DO-1204	20.0 cm	8"	str
DO-1205	24.0 cm	9 1/2"	str
DO-1206	18.0 cm	7"	cvd
DO-1207	20.0 cm	8"	cvd
DO-1208	24.0 cm	9 1/2"	cvd

Sponge Forceps (smooth jaw)



REF #	SIZE cm	SIZE in	SHAPE
DO-1209	18.0 cm	7"	str
DO-1210	20.0 cm	8"	str
DO-1211	24.0 cm	9 1/2"	str
DO-1212	18.0 cm	7"	cvd
DO-1213	20.0 cm	8"	cvd
DO-1214	24.0 cm	9 1/2"	cvd

Foerster  
Sponge Forceps (serrated jaw)



REF #	SIZE cm	SIZE in	SHAPE
DO-1215	18.0 cm	7"	str
DO-1216	20.0 cm	8"	str
DO-1217	24.0 cm	9 1/2"	str
DO-1218	18.0 cm	7"	cvd
DO-1219	20.0 cm	8"	cvd
DO-1220	24.0 cm	9 1/2"	cvd

Foerster  
Sponge Forceps (small serrated jaw)



REF #	SIZE cm	SIZE in	SHAPE
DO-1221	18.0 cm	7"	str
DO-1222	20.0 cm	8"	str
DO-1223	24.0 cm	9 1/2"	str
DO-1224	18.0 cm	7"	cvd
DO-1225	20.0 cm	8"	cvd
DO-1226	24.0 cm	9 1/2"	cvd

Foerster  
Sponge Forceps (round small serrated jaw)



REF #	SIZE cm	SIZE in	SHAPE
DO-1227	18.5 cm	7 1/4"	str
DO-1228	24.5 cm	9 3/4"	str

Rampley  
Sponge Forceps



REF #	SIZE cm	SIZE in	SHAPE
DO-1229	24.0 cm	9 1/2"	str
DO-1230	24.0 cm	9 1/2"	cvd

Foerster  
Sponge Forceps





## GENERAL INSTRUMENTS

### RETRACTORS

Micro Hooklet, Skin Hook, Hooklet, Flexible Hooklet



Graefe  
Micro Hooklet

REF #	SIZE cm	SIZE in	SHAPE
EO-1280	15.0 cm	6"	sharp
EO-1281	15.0 cm	6"	blunt



Standard  
Skin Hook

REF #	SIZE cm	SIZE in	SHAPE
EO-1282	16.0 cm	6 1/2"	Fig.1
EO-1283	16.0 cm	6 1/2"	Fig.2
EO-1284	16.0 cm	6 1/2"	Fig.3
EO-1285	16.0 cm	6 1/2"	Fig.4



Guthrie  
Skin Hook

REF #	SIZE cm	SIZE in	SHAPE
EO-1286	15.5 cm	6"	Fig.1
EO-1287	15.5 cm	6"	Fig.2



Fig.1 Fig.2



Standard  
Hooklet

REF #	SIZE cm	SIZE in	SHAPE
EO-1288	16.5 cm	6 1/2"	Fig.1
EO-1289	16.5 cm	6 1/2"	Fig.2
EO-1290	16.5 cm	6 1/2"	Fig.3
EO-1291	16.5 cm	6 1/2"	Fig.4

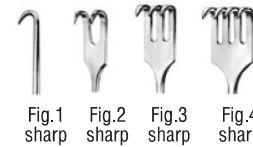

Fig.1 sharp Fig.2 sharp Fig.3 sharp Fig.4 sharp



Standard  
Flexible Hooklet

REF #	SIZE cm	SIZE in	SHAPE
EO-1292	16.0 cm	6 1/4"	Fig.1
EO-1293	16.0 cm	6 1/4"	Fig.2
EO-1294	16.0 cm	6 1/4"	Fig.3

REF #	SIZE cm	SIZE in	SHAPE
EO-1295	16.0 cm	6 1/4"	Fig.1
EO-1296	16.0 cm	6 1/4"	Fig.2
EO-1297	16.0 cm	6 1/4"	Fig.3

blunt



Fig.1 sharp Fig.2 sharp Fig.3 sharp



Fig.1 blunt Fig.2 blunt Fig.3 blunt



Standard  
Hooklet

REF #	SIZE cm	SIZE in	SHAPE
EO-1298	16.5 cm	6 1/2"	sharp
EO-1299	16.5 cm	6 1/2"	blunt



## GENERAL INSTRUMENTS

### RETRACTORS

Skin Hook, Hooklet, Vessel Hook



REF #	SIZE cm	SIZE in	SHAPE
EO-1300	16.0 cm	6¼"	sharp

O'Connor  
Skin Hook



REF #	SIZE cm	SIZE in	SHAPE
EO-1301	16.0 cm	6¼"	8 mm
EO-1302	16.0 cm	6¼"	10 mm
EO-1303	16.0 cm	6¼"	12 mm
EO-1304	16.0 cm	6¼"	14 mm
EO-1305	16.0 cm	6¼"	16 mm
EO-1306	16.0 cm	6¼"	18 mm

Desmarres  
Saddle Hook



REF #	SIZE cm	SIZE in	SHAPE
EO-1307	16.5 cm	6½"	Fig.1
EO-1308	16.5 cm	6½"	Fig.2
EO-1309	16.5 cm	6½"	Fig.3
EO-1310	16.5 cm	6½"	Fig.4

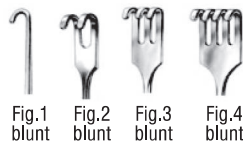

Standard  
Hooklet



REF #	SIZE cm	SIZE in	SHAPE
EO-1311	16.0 cm	6¼"	14x8 mm



Standard  
Hooklet



REF #	SIZE cm	SIZE in
EO-1312	20.0 cm	4¾"

Standard  
Vessel Hook (with button end)



REF #	SIZE cm	SIZE in	SHAPE
EO-1313	17.5 cm	7"	Fig.1
EO-1314	17.5 cm	7"	Fig.2
EO-1315	17.5 cm	7"	Fig.3
EO-1316	17.5 cm	7"	Fig.4
EO-1317	17.5 cm	7"	Fig.5
EO-1318	17.5 cm	7"	Fig.6

Fig.1	Fig.2	Fig.3
18x7 mm	16x5 mm	7x4 mm

Fig.4	Fig.5	Fig.6
10x3 mm	7x4 mm	10x4 mm

Meyerding  
Hooklet



## GENERAL INSTRUMENTS

### RETRACTORS Saddle Hook, Hooklet



REF #	SIZE cm	SIZE in	SHAPE
EO-1319	16.0 cm	6¼"	12 mm
EO-1320	16.0 cm	6¼"	14 mm
EO-1321	16.0 cm	6¼"	16 mm
EO-1322	16.0 cm	6¼"	18 mm

Standard  
Saddle Hook



REF #	SIZE cm	SIZE in	SHAPE
EO-1323	16.0 cm	6¼"	10x6 mm
EO-1324	16.0 cm	6¼"	17x5 mm
EO-1325	16.0 cm	6¼"	20x6 mm
EO-1326	16.0 cm	6¼"	22x8 mm

Langenbeck-Mini  
Hooklet



REF #	SIZE cm	SIZE in	SHAPE
EO-1327	16.5 cm	6½"	Fig.1
EO-1328	16.5 cm	6½"	Fig.2
EO-1329	16.5 cm	6½"	Fig.3
EO-1330	16.5 cm	6½"	Fig.4

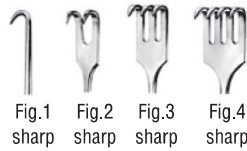

Standard  
Hooklet



REF #	SIZE cm	SIZE in	SHAPE
EO-1331	16.5 cm	6½"	Fig.1
EO-1332	16.5 cm	6½"	Fig.2
EO-1333	16.5 cm	6½"	Fig.3
EO-1334	16.5 cm	6½"	Fig.4

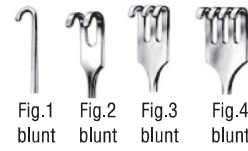

Standard  
Hooklet



REF #	SIZE cm	SIZE in	SHAPE
EO-1335	15.0 cm	6"	Fig.1
EO-1336	15.0 cm	6"	Fig.2



Senn-Green  
Hooklet



REF #	SIZE cm	SIZE in	SHAPE
EO-1337	14.0 cm	5½"	8x4 mm 15x5.5 mm

Ragnell-Davis  
Hooklet



## GENERAL INSTRUMENTS

### RETRACTORS Hooklet, Retractor, Saddle Hook



REF #	SIZE cm	SIZE in	SHAPE
EO-1338	16.0 cm	6 1/4"	Fig.1
EO-1339	16.0 cm	6 1/4"	Fig.2

Fig.1  
sharp prong  
blade 20x7 mm

Fig.2  
blunt prong  
blade 20x7 mm

Senn-Miller  
Hooklet



REF #	SIZE cm	SIZE in
EO-1340	20.5 cm	8"

Cushing  
Retractor



REF #	SIZE cm	SIZE in	SHAPE
EO-1341	24.0 cm	9 1/2"	8 mm
EO-1342	24.0 cm	9 1/2"	10 mm
EO-1343	24.0 cm	9 1/2"	12 mm
EO-1344	24.0 cm	9 1/2"	14 mm
EO-1345	24.0 cm	9 1/2"	16 mm
EO-1346	24.0 cm	9 1/2"	18 mm

Cushing  
Saddle Hook



REF #	SIZE cm	SIZE in	SHAPE
EO-1347	24.0 cm	9 1/2"	8 mm
EO-1348	24.0 cm	9 1/2"	11 mm
EO-1349	24.0 cm	9 1/2"	15 mm
EO-1350	24.0 cm	9 1/2"	17 mm
EO-1351	24.0 cm	9 1/2"	20 mm
EO-1352	24.0 cm	9 1/2"	23 mm

Gil-Vernet  
Saddle Hook (flexible shaft)



REF #	SIZE cm	SIZE in	SHAPE
EO-1353	19.0 cm	7 1/2"	Fig.1
EO-1354	19.0 cm	7 1/2"	Fig.2

Fig.1  
smooth  
blade end

Fig.2  
toothed  
blade end

Strandell-Stille  
Hooklet



REF #	SIZE cm	SIZE in	SHAPE
EO-1355	08.0 cm	3"	sharp

Kaye-Millard  
Hooklet



**GENERAL INSTRUMENTS**

**RETRACTORS**

Hooklet, Retractor, Saddle Hook, Vein Hook



**Cushing  
Saddle Hook**

REF #	SIZE cm	SIZE in	SHAPE
EO-1356	20.5 cm	8"	8 mm
EO-1357	20.5 cm	8"	10 mm
EO-1358	20.5 cm	8"	12 mm
EO-1359	20.5 cm	8"	14 mm
EO-1360	20.5 cm	8"	16 mm
EO-1361	20.5 cm	8"	18 mm



**Standard  
Hooklet**

REF #	SIZE cm	SIZE in	SHAPE
EO-1362	16.5 cm	6½"	sharp
EO-1363	16.5 cm	6½"	blunt



**Brom  
Vein Hook**

REF #	SIZE cm	SIZE in
EO-1364	19.5 cm	7¾"



**Volkman  
Retractor**

REF #	SIZE cm	SIZE in	SHAPE
EO-1365	21.5 cm	8½"	Fig.1
EO-1366	21.5 cm	8½"	Fig.2
EO-1367	21.5 cm	8½"	Fig.3
EO-1368	21.5 cm	8½"	Fig.4
EO-1369	21.5 cm	8½"	Fig.5

sharp

EO-1370	21.5 cm	8½"	Fig.1
EO-1371	21.5 cm	8½"	Fig.2
EO-1372	21.5 cm	8½"	Fig.3
EO-1373	21.5 cm <td 8½"	Fig.4	
EO-1374	21.5 cm	8½"	Fig.5

blunt



**Klapp  
Retractor**

REF #	SIZE cm	SIZE in	SHAPE
EO-1375	17.5 cm	7"	Fig.1
EO-1376	17.5 cm	7"	Fig.2
EO-1377	17.5 cm	7"	Fig.3



**Fig.1  
12x6 mm  
blunt**



**Fig.2  
12x11 mm  
blunt**



**Fig.3  
15x11 mm  
blunt**



**Ollier  
Retractor**

REF #	SIZE cm	SIZE in	SHAPE
EO-1378	23.0 cm	9"	Fig.1
EO-1379	23.0 cm	9"	Fig.2



**Fig.1  
36x30 mm**



**Fig.2  
36x60 mm**



## GENERAL INSTRUMENTS

### RETRACTORS Retractor



Standard  
Retractor

REF #	SIZE cm	SIZE in	SHAPE
EO-1380	21.5 cm	8½"	Fig.1
EO-1381	21.5 cm	8½"	Fig.2
EO-1382	21.5 cm	8½"	Fig.3
EO-1383	21.5 cm	8½"	Fig.4
EO-1384	21.5 cm	8½"	Fig.5
sharp			
EO-1385	21.5 cm	8½"	Fig.1
EO-1386	21.5 cm	8½"	Fig.2
EO-1387	21.5 cm	8½"	Fig.3
EO-1388	21.5 cm	8½"	Fig.4
EO-1389	21.5 cm	8½"	Fig.5
semi-sharp			
EO-1390	21.5 cm	8½"	Fig.1
EO-1391	21.5 cm	8½"	Fig.2
EO-1392	21.5 cm	8½"	Fig.3
EO-1393	21.5 cm	8½"	Fig.4
EO-1394	21.5 cm	8½"	Fig.5
blunt			



Fig.1



Fig.2



Fig.3



Fig.4



Fig.5



Fig.6  
sharp



Fig.7  
blunt



Fig.8  
sharp

REF #	SIZE cm	SIZE in	SHAPE
EO-1395	21.5 cm	8½"	Fig.6
EO-1396	21.5 cm	8½"	Fig.7
EO-1397	21.5 cm	8½"	Fig.8



Kocher  
Retractor

REF #	SIZE cm	SIZE in	SHAPE
EO-1398	22.0 cm	8¾"	1 Prong
EO-1399	22.0 cm	8¾"	2 Prong
EO-1400	22.0 cm	8¾"	3 Prong
EO-1401	22.0 cm	8¾"	4 Prong
EO-1402	22.0 cm	8¾"	6 Prong
EO-1403	22.0 cm	8¾"	8 Prong
sharp			
EO-1404	22.0 cm	8¾"	1 Prong
EO-1405	22.0 cm	8¾"	2 Prong
EO-1406	22.0 cm	8¾"	3 Prong
EO-1407	22.0 cm	8¾"	4 Prong
EO-1408	22.0 cm	8¾"	6 Prong
EO-1409	22.0 cm	8¾"	8 Prong
semi-sharp			
EO-1410	22.0 cm	8¾"	1 Prong
EO-1411	22.0 cm	8¾"	2 Prong
EO-1412	22.0 cm	8¾"	3 Prong
EO-1413	22.0 cm	8¾"	4 Prong
EO-1414	22.0 cm	8¾"	6 Prong
EO-1415	22.0 cm	8¾"	8 Prong
blunt			



Retractor

REF #	SIZE cm	SIZE in	SHAPE
EO-1416	22.5 cm	8¾"	2 Prong
EO-1417	22.5 cm	8¾"	3 Prong
EO-1418	22.5 cm	8¾"	4 Prong
EO-1419	22.5 cm	8¾"	6 Prong
sharp			
EO-1420	22.5 cm	8¾"	2 Prong
EO-1421	22.5 cm	8¾"	3 Prong
EO-1422	22.5 cm	8¾"	4 Prong
EO-1423	22.5 cm	8¾"	6 Prong
blunt			



Wassmund  
Retractor

REF #	SIZE cm	SIZE in	SHAPE
EO-1424	20.5 cm	8"	Fig.1
Fig.1 33x21 mm			



Korte  
Retractor

REF #	SIZE cm	SIZE in	SHAPE
EO-1425	24.5 cm	9¾"	Fig.1
EO-1426	24.5 cm	9¾"	Fig.2
Fig.1 40x30 mm sharp			
Fig.2 40x30 mm blunt			



## GENERAL INSTRUMENTS

### RETRACTORS



REF #	SIZE cm	SIZE in	SHAPE
EO-1427	25.5 cm	10"	Fig.1
EO-1428	25.5 cm	10"	Fig.2
EO-1429	25.5 cm	10"	Fig.3
EO-1430	25.5 cm	10"	Fig.4

Fig.1  
40x40 mm  
4 prong

Fig.2  
45x50 mm  
5 prong

Fig.3  
50x60 mm  
6 prong

Fig.4  
70x70 mm  
6 prong

Israel  
Retractor



REF #	SIZE cm	SIZE in	SHAPE
EO-1431	22.5 cm	8 3/4"	Fig.1
EO-1432	22.5 cm	8 3/4"	Fig.2
EO-1433	22.5 cm	8 3/4"	Fig.3
EO-1434	22.5 cm	8 3/4"	Fig.4
EO-1435	22.5 cm	8 3/4"	Fig.5

Fig.1  
30x11 mm

Fig.2  
30x14 mm

Fig.3  
30x16 mm

Fig.4  
40x11 mm

Fig.5  
50x11 mm

Langenbeck  
Retractor



REF #	SIZE cm	SIZE in	SHAPE
EO-1436	21.0 cm	8 1/4"	Fig.1

Fig.1  
65x20 mm

Langenbeck  
Retractor



REF #	SIZE cm	SIZE in	SHAPE
EO-1437	22.5 cm	8 3/4"	Fig.1

Fig.1  
85x15 mm

Langenbeck  
Retractor



REF #	SIZE cm	SIZE in	SHAPE
EO-1438	20.0 cm	8"	13x15 mm

Little  
Retractor



REF #	SIZE cm	SIZE in	SHAPE
EO-1439	23.0 cm	9"	Fig.1
EO-1440	23.0 cm	9"	Fig.2
EO-1441	23.0 cm	9"	Fig.3
EO-1442	23.0 cm	9"	Fig.4
EO-1443	23.0 cm	9"	Fig.5

Fig.1  
40x18 mm

Fig.2  
60x20 mm

Fig.3  
60x25 mm

Fig.4  
75x30 mm

Fig.5  
75x40 mm

Kocher  
Retractor

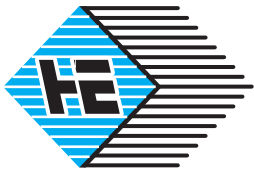

## GENERAL INSTRUMENTS

### RETRACTORS Retractor



Langenbeck  
Retractor

REF #	SIZE cm	SIZE in	SHAPE
EO-1444	22.5 cm	8 3/4"	Fig.1
EO-1445	22.5 cm	8 3/4"	Fig.2
EO-1446	22.5 cm	8 3/4"	Fig.3
EO-1447	22.5 cm	8 3/4"	Fig.4
EO-1448	22.5 cm	8 3/4"	Fig.5

Fig.1	Fig.2
30x11 mm	30x14 mm
Fig.3	Fig.4
30x16 mm	40x11 mm
Fig.5	
50x11 mm	



Richardson  
Retractor

REF #	SIZE cm	SIZE in	SHAPE
EO-1449	21.5 cm	8 1/2"	Fig.1
EO-1450	21.5 cm	8 1/2"	Fig.2
EO-1451	21.5 cm	8 1/2"	Fig.3
EO-1452	21.5 cm	8 1/2"	Fig.4
EO-1453	21.5 cm	8 1/2"	Fig.5
EO-1454	21.5 cm	8 1/2"	Fig.6
EO-1455	21.5 cm	8 1/2"	Fig.7
EO-1456	21.5 cm	8 1/2"	Fig.8

Fig.1	Fig.2
25x10 mm	40x13 mm
Fig.3	Fig.4
60x13 mm	40x18 mm
Fig.5	Fig.6
60x18 mm	85x18 mm
Fig.7	Fig.8
60x25 mm	85x25 mm



Lahey  
Retractor

REF #	SIZE cm	SIZE in	SHAPE
EO-1457	19.5 cm	7 3/4"	31x6 mm



Kocher  
Retractor

REF #	SIZE cm	SIZE in	SHAPE
EO-1458	22.0 cm	8 3/4"	Fig.1
EO-1459	23.0 cm	9"	Fig.2
EO-1460	23.0 cm	9"	Fig.3

Fig.1	Fig.2
40x10 mm	40x15 mm
Fig.3	
40x20 mm	



Kocher-Langenbeck  
Retractor

REF #	SIZE cm	SIZE in	SHAPE
EO-1461	21.5 cm	8 1/2"	Fig.1
EO-1462	21.5 cm	8 1/2"	Fig.2
EO-1463	21.5 cm	8 1/2"	Fig.3
EO-1464	21.5 cm	8 1/2"	Fig.4
EO-1465	21.5 cm	8 1/2"	Fig.5
EO-1466	21.5 cm	8 1/2"	Fig.6
EO-1467	21.5 cm	8 1/2"	Fig.7
EO-1468	21.5 cm	8 1/2"	Fig.8
EO-1469	21.5 cm	8 1/2"	Fig.9

Fig.1	Fig.2
25x6 mm	35x8 mm
Fig.3	Fig.4
35x11 mm	35x15 mm
Fig.5	Fig.6
40x11 mm	55x11 mm
Fig.7	Fig.8
70x14 mm	80x12 mm
Fig.9	
80x16 mm	



Richardson  
Retractor

REF #	SIZE cm	SIZE in	SHAPE
EO-1470	23.5 cm	9 1/4"	Fig.1
EO-1471	24.0 cm	9 1/2"	Fig.2
EO-1472	24.0 cm	9 1/2"	Fig.3

Fig.1	Fig.2
30x21 mm	37x29 mm
Fig.3	
45x40 mm	



## GENERAL INSTRUMENTS

### RETRACTORS Retractor



Zenker  
Retractor

REF #	SIZE cm	SIZE in	SHAPE
E0-1473	25.0 cm	9 3/4"	Fig.1
E0-1474	26.5 cm	10 1/2"	Fig.2
E0-1475	27.5 cm	10 3/4"	Fig.3
E0-1476	28.5 cm	11 1/4"	Fig.4
E0-1477	30.5 cm	12"	Fig.5

Fig.1	Fig.2
35x8 mm	60x12 mm
Fig.3	Fig.4
75x12 mm	85x20 mm
Fig.5	
100x25 mm	



Kocher  
Retractor

REF #	SIZE cm	SIZE in	SHAPE
E0-1478	21.5 cm	8 1/2"	Fig.1
E0-1479	21.5 cm	8 1/2"	Fig.2

Fig.1	Fig.2
19x12 mm	21x14 mm



Middeldorp  
Retractor

REF #	SIZE cm	SIZE in	SHAPE
E0-1480	21.5 cm	8 1/2"	Fig.1
E0-1481	23.0 cm	9"	Fig.2
E0-1482	24.5 cm	9 3/4"	Fig.3

Fig.1	Fig.2
14x17 mm	20x22 mm
Fig.3	
26x30 mm	



Richardson-Eastman  
Retractor

REF #	SIZE cm	SIZE in	SHAPE
E0-1483	26.0 cm	10 1/4"	Fig.1
E0-1484	27.0 cm	10 5/8"	Fig.2

Fig.1	Fig.2
28x20 mm	49x38 mm
36x28 mm	71x43 mm



Richardson  
Retractor

REF #	SIZE cm	SIZE in	SHAPE
E0-1485	24.0 cm	9 1/2"	Fig.1

Fig.1
53x22 mm



Kelly  
Retractor

REF #	SIZE cm	SIZE in	SHAPE
E0-1486	26.0 cm	10 1/4"	Fig.1
E0-1487	26.0 cm	10 1/4"	Fig.2
E0-1488	26.0 cm	10 1/4"	Fig.3

Fig.1
38x51 mm

Fig.2
51x64 mm

Fig.3
64x76 mm

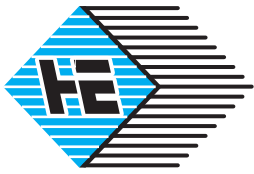

## GENERAL INSTRUMENTS

### RETRACTORS Retractor

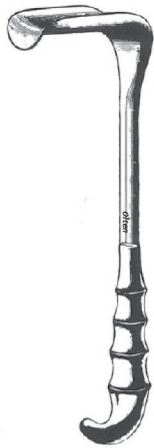

REF #	SIZE cm	SIZE in	SHAPE
EO-1489	24.0 cm	9½"	Fig.1
EO-1490	24.0 cm	9½"	Fig.2
EO-1491	24.0 cm	9½"	Fig.3
EO-1492	24.0 cm	9½"	Fig.4
EO-1493	24.0 cm	9½"	Fig.5

Fig.1	Fig.2
20x25 mm	25x31 mm
Fig.3	Fig.4
38x38 mm	19x51 mm
Fig.5	
41x64 mm	

Richardson Grip  
Retractor



REF #	SIZE cm	SIZE in	SHAPE
EO-1494	26.0 cm	10¼"	Fig.1
EO-1495	26.0 cm	10¼"	Fig.2
EO-1496	26.0 cm	10¼"	Fig.3
EO-1497	26.0 cm	10¼"	Fig.4

Fig.1	Fig.2
38x51 mm	51x64 mm
Fig.3	Fig.4
64x76 mm	70x82 mm

Kelly Grip  
Retractor



REF #	SIZE cm	SIZE in	SHAPE
EO-1498	26.0 cm	10¼"	Fig.1
EO-1499	26.0 cm	10¼"	Fig.2
EO-1500	26.0 cm	10¼"	Fig.3
EO-1501	26.0 cm	10¼"	Fig.4
EO-1502	26.0 cm	10¼"	Fig.5
EO-1503	26.0 cm	10¼"	Fig.6

Fig.1	Fig.2
60x20 mm	50x30 mm
Fig.3	Fig.4
100x30 mm	120x30 mm
Fig.5	Fig.6
140x30 mm	140x40 mm

Hosel  
Retractor



REF #	SIZE cm	SIZE in	SHAPE
EO-1504	27.0 cm	10¾"	Fig.1
EO-1505	27.0 cm	10¾"	Fig.2
EO-1506	28.0 cm	11"	Fig.3

Fig.1	Fig.2
45x45 mm	45x50 mm
Fig.3	
55x70 mm	

Middeldorpf  
Retractor



REF #	SIZE cm	SIZE in	SHAPE
EO-1507	24.0 cm	9½"	Fig.1

Fig.1  
50x85 mm

Doyen  
Retractor



REF #	SIZE cm	SIZE in	SHAPE
EO-1508	24.0 cm	9½"	Fig.1

Fig.1  
70x25 mm

Kocher  
Retractor



## GENERAL INSTRUMENTS

### RETRACTORS Retractor



Doyen-Stille  
Retractor

REF #	SIZE cm	SIZE in	SHAPE
EO-1509	26.0 cm	10 1/4"	Fig.1
EO-1510	26.0 cm	10 1/4"	Fig.2
EO-1511	26.0 cm	10 1/4"	Fig.3

Fig.1	Fig.2
90x28 mm	106x30 mm
Fig.3	
120x52 mm	



Martin  
Retractor

REF #	SIZE cm	SIZE in	SHAPE
EO-1512	26.0 cm	10 1/4"	Fig.1

Fig.1
106x27 mm



Fritsch  
Retractor

REF #	SIZE cm	SIZE in	SHAPE
EO-1513	23.5 cm	9 1/4"	Fig.1
EO-1514	24.0 cm	9 1/2"	Fig.2
EO-1515	25.0 cm	9 3/4"	Fig.3
EO-1516	25.0 cm	9 3/4"	Fig.4
EO-1517	25.5 cm	10"	Fig.5
EO-1518	26.5 cm	10 1/2"	Fig.6

Fig.1	Fig.2
30x30 mm	32x40 mm
Fig.3	Fig.4
40x50 mm	40x60 mm
Fig.5	Fig.6
45x75 mm	65x85 mm



Simon  
Retractor

REF #	SIZE cm	SIZE in	SHAPE
EO-1519	28.0 cm	11"	Fig.1
EO-1520	28.0 cm	11"	Fig.2

Fig.1	Fig.2
115x22 mm	115x27 mm



Kocher  
Retractor

REF #	SIZE cm	SIZE in	SHAPE
EO-1521	25.0 cm	9 3/4"	Fig.1
EO-1522	25.0 cm	9 3/4"	Fig.2
EO-1523	25.0 cm	9 3/4"	Fig.3

Fig.1	Fig.2
80x45 mm	80x55 mm
Fig.3	
80x65 mm	



Davidson  
Scapula Retractor

REF #	SIZE cm	SIZE in	SHAPE
EO-1524	19.0 cm	7 1/2"	Fig.1
EO-1525	18.5 cm	7 1/4"	Fig.2

Fig.1
75x50 mm
Fig.2
75x90 mm

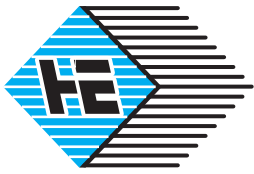

## GENERAL INSTRUMENTS

### RETRACTORS Retractor



REF # SIZE cm SIZE in SHAPE  
EO-1526 25.5 cm 10" Fig.1

Fig.1  
125x37 mm

Sauerbruch  
Retractor



REF # SIZE cm SIZE in SHAPE  
EO-1527 24.0 cm 9½" Fig.1  
EO-1528 24.0 cm 9½" Fig.2  
EO-1529 24.0 cm 9½" Fig.3

Fig.1  
82x22 mm

Fig.2  
108x43 mm

Fig.3  
115x65 mm

Coryllos  
Retractor



REF # SIZE cm SIZE in SHAPE  
EO-1530 25.5 cm 10" Fig.1  
EO-1531 25.5 cm 10" Fig.2  
EO-1532 25.5 cm 10" Fig.3  
EO-1533 25.5 cm 10" Fig.4  
EO-1534 25.5 cm 10" Fig.5  
EO-1535 25.5 cm 10" Fig.6

Fig.1 Fig.2  
80x20 mm 100x20 mm

Fig.3 Fig.4  
120x25 mm 140x25 mm

Fig.5 Fig.6  
160x30 mm 180x30 mm

Brunner  
Retractor



REF # SIZE cm SIZE in SHAPE  
EO-1536 25.5 cm 10" Fig.1  
EO-1537 25.5 cm 10" Fig.2  
EO-1538 25.5 cm 10" Fig.3  
EO-1539 25.5 cm 10" Fig.4  
EO-1540 25.5 cm 10" Fig.5  
EO-1541 25.5 cm 10" Fig.6  
EO-1542 25.5 cm 10" Fig.7

Fig.1 Fig.2  
80x20 mm 100x25 mm

Fig.3 Fig.4  
120x25 mm 130x30 mm

Fig.5 Fig.6  
140x30 mm 160x30 mm

Fig.7  
180x30 mm

Brunner  
Retractor



REF # SIZE cm SIZE in SHAPE  
EO-1543 22.5 cm 8¾" Fig.1  
EO-1544 22.5 cm 8¾" Fig.2  
EO-1545 22.5 cm 8¾" Fig.3

Fig.1 Fig.2  
50x15 mm 63x23 mm

Fig.3  
80x20 mm

Sauerbruch  
Retractor



REF # SIZE cm SIZE in SHAPE  
EO-1546 19.0 cm 7½" Fig.1  
EO-1547 19.0 cm 7½" Fig.2

Fig.1 Fig.2  
15x15 mm 15x23 mm

Crawford  
Aorta Retractor

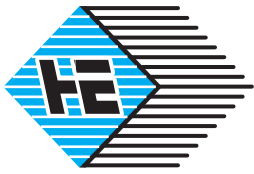

## GENERAL INSTRUMENTS

RETRACTORS  
Retractor, Aorta Retractor



REF #	SIZE cm	SIZE in	SHAPE
EO-1548	21.5 cm	8½"	Fig.1
EO-1549	21.5 cm	8½"	Fig.2
EO-1550	21.5 cm	8½"	Fig.3
EO-1551	21.5 cm	8½"	Fig.4
EO-1552	21.5 cm	8½"	Fig.5
EO-1553	21.5 cm	8½"	Fig.6

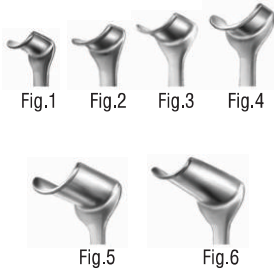

Ross  
Aorta Retractor (flexible shaft)



REF #	SIZE cm	SIZE in
EO-1554	29.0 cm	11½"

Polloson  
Retractor

REF #	SIZE cm	SIZE in	SHAPE	FIGUER
EO-1555	18.0 cm	7"	19 mm	Fig. 1
EO-1556	21.5 cm	8½"	22 mm	Fig. 2
EO-1557	25.0 cm	9¾"	25 mm	Fig. 3
EO-1558	31.0 cm	12¼"	25 mm	Fig. 4
EO-1559	33.0 cm	13"	25 mm	Fig. 5
EO-1560	36.0 cm	14¼"	25 mm	Fig. 6
EO-1561	30.0 cm	11¾"	38 mm	Fig. 7
EO-1562	31.0 cm	12¼"	50 mm	Fig. 8
EO-1563	31.5 cm	12½"	75 mm	Fig. 9

Deaver  
Retractor





## GENERAL INSTRUMENTS

### RETRACTORS

Retractor, Atrium Retractor, Liver Retractor



REF #	SIZE cm	SIZE in
EO-1564	25.5 cm	10"



Polloson  
Retractor

REF #	SIZE cm	SIZE in	SHAPE
EO-1568	31.5 cm	12½"	25 mm
EO-1569	31.5 cm	12½"	38 mm
EO-1570	31.5 cm	12½"	50 mm
EO-1571	31.5 cm	12½"	63 mm
EO-1572	31.5 cm	12½"	75 mm
EO-1573	31.5 cm	12½"	90 mm
EO-1574	31.5 cm	12½"	100 mm



Deaver  
Retractor

REF #	SIZE cm	SIZE in	SHAPE
EO-1578	23.0 cm	9"	Fig.1
EO-1579	23.0 cm	9"	Fig.2



Harrington  
Retractor

Fig.1	Fig.2
127x40 mm	127x62 mm

REF #	SIZE cm	SIZE in	SHAPE
EO-1565	25.0 cm	9¾"	Fig.1
EO-1566	25.0 cm	9¾"	Fig.2
EO-1567	27.0 cm	10½"	Fig.3



Cooley  
Atrium Retractor

Fig.1	Fig.2
48x48 mm right	48x48 mm right, serrated



Fig.3  
30x48 mm  
left

REF #	SIZE cm	SIZE in	SHAPE
EO-1575	25.0 cm	9¾"	Fig.1
EO-1576	25.0 cm	9¾"	Fig.2
EO-1577	25.0 cm	9¾"	Fig.3



Mikulicz  
Liver Retractor

Fig.1	Fig.2
95x35 mm	120x50 mm
Fig.3 150x50 mm	

REF #	SIZE cm	SIZE in	SHAPE
EO-1580	26.0 cm	10¼"	Fig.1



Mikulicz  
Retractor

Fig.1
85x50 mm



## GENERAL INSTRUMENTS

### RETRACTORS

Retractor, Pelvis Retractor, Abdominal Spatula



REF #	SIZE cm	SIZE in	SHAPE
EO-1581	29.0 cm	11½"	Fig.1
EO-1582	29.0 cm	11½"	Fig.2
EO-1583	33.0 cm	13"	Fig.3

Fig.1  
130x60 mm  
35x45 mm

Fig.2  
180x60 mm  
60x45 mm

Fig.3  
180x60 mm  
60x45 mm

St. Marks  
Pelvis Retractor



REF #	SIZE cm	SIZE in	SHAPE
EO-1584	15.0 cm	6"	Fig.1
EO-1585	16.0 cm	6¼"	Fig.2
EO-1586	17.0 cm	6½"	Fig.3

Fig.1                      Fig.2  
24x20 mm              29x26 mm  
30x28 mm              36x36 mm

Fig.3  
33x29 mm  
38x43 mm

Roux  
Retractor



REF #	SIZE cm	SIZE in	SHAPE
EO-1587	31.0 cm	12¼"	Fig.1

Fig.1  
100x45 mm

Kummel  
Abdominal Spatula

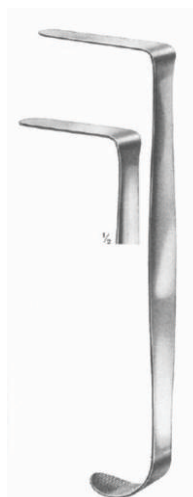

REF #	SIZE cm	SIZE in	SHAPE
EO-1588	27.0 cm	10½"	Fig.1
EO-1589	27.0 cm	10½"	Fig.2
EO-1590	27.0 cm	10½"	Fig.3

Fig.1  
45x25 mm

Fig.2  
73x28 mm

Fig.3  
82x28 mm

Heaney  
Retractor



REF #	SIZE cm	SIZE in	SHAPE
EO-1591	14.0 cm	5½"	Fig.1
EO-1592	16.0 cm	6¼"	Fig.2

Fig.1                      Fig.2  
38x28 mm              52x34 mm  
32x21 mm              36x27 mm

Collin-Hartmann  
Retractor



REF #	SIZE cm	SIZE in	SHAPE
EO-1593	27.5 cm	10¾"	Fig.1
EO-1594	27.5 cm	10¾"	Fig.2

Fig.1  
190x38 mm

Fig.2  
190x57 mm

Kelly  
Retractor

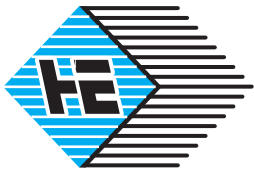

## GENERAL INSTRUMENTS

### RETRACTORS Retractor, Abdominal Spatula



REF #	SIZE cm	SIZE in	SHAPE
EO-1595	27.5 cm	10 $\frac{3}{4}$ "	20 mm
EO-1596	27.5 cm	10 $\frac{3}{4}$ "	30 mm
EO-1597	27.5 cm	10 $\frac{3}{4}$ "	40 mm

Kader  
Abdominal Spatula



REF #	SIZE cm	SIZE in	SHAPE
EO-1598	15.0 cm	6"	Fig.1
EO-1599	15.0 cm	6"	Fig.2

Fig.1	Fig.2
23x16 mm	27x16 mm
26x16 mm	30x16 mm

Farabeuf  
Retractor



REF #	SIZE cm	SIZE in	SHAPE
EO-1600	11.5 cm	4 $\frac{1}{2}$ "	Fig.1
EO-1601	11.5 cm	4 $\frac{1}{2}$ "	Fig.2

Fig.1	Fig.2
26x10 mm	30x10 mm
30x13 mm	34x13 mm

Farabeuf  
Retractor



REF #	SIZE cm	SIZE in	SHAPE
EO-1602	14.5 cm	5 $\frac{3}{4}$ "	8x6 mm

Roux-Mini  
Retractor



REF #	SIZE cm	SIZE in	SHAPE
EO-1603	19.0 cm	7 $\frac{1}{2}$ "	Fig.1

Fig.1
40x40 mm
30x30 mm

Goelet  
Retractor



REF #	SIZE cm	SIZE in
EO-1604	12.5 cm	5"

Roux-Baby  
Retractor



## GENERAL INSTRUMENTS

### RETRACTORS Retractor



REF #	SIZE cm	SIZE in
EO-1605	13.5 cm	5 1/4"

Parker  
Retractor



REF #	SIZE cm	SIZE in	SHAPE
EO-1606	13.5 cm	5 1/4"	Fig.1
EO-1607	13.5 cm	5 1/4"	Fig.2

Fig.1	Fig.2
19x15 mm	22x15 mm
19x15 mm	22x15 mm

Parker  
Retractor



REF #	SIZE cm	SIZE in	SHAPE
EO-1608	17.5 cm	7"	Fig.1
EO-1609	17.5 cm	7"	Fig.2

Fig.1	Fig.2
26x25 mm	29x25 mm
24x25 mm	27x25 mm

Parker  
Retractor



REF #	SIZE cm	SIZE in	SHAPE
EO-1610	16.0 cm	6 1/4"	Fig.1
EO-1611	16.0 cm	6 1/4"	Fig.2

Fig.1	Fig.2
21x24 mm	25x24 mm
68x24 mm	72x24 mm

Parker-Mott  
Retractor



REF #	SIZE cm	SIZE in	SHAPE
EO-1612	20.0 cm	8"	Fig.1
EO-1613	20.0 cm	8"	Fig.2

Fig.1	Fig.2
42x13 mm	47x13 mm
42x26 mm	46x26 mm

Mathieu  
Retractor



REF #	SIZE cm	SIZE in	SHAPE
EO-1614	21.0 cm	8 1/4"	Fig.1
EO-1615	21.0 cm	8 1/4"	Fig.2

Fig.1	Fig.2
21x15 mm	25x15 mm
40x15 mm	45x15 mm

US-Army Navy  
Retractor



**GENERAL INSTRUMENTS**  
**SELF RETRAINING RETRACTORS**  
 Wound Spreader, Fat Spreader, Retractor



REF #	SIZE cm	SIZE in	SHAPE
EO-1616	20.0 cm	8"	6.0 mm
EO-1617	20.0 cm	8"	8.0 mm
EO-1618	20.0 cm	8"	10.0 mm
EO-1619	20.0 cm	8"	12.0 mm
EO-1620	20.0 cm	8"	17.0 mm
EO-1621	20.0 cm	8"	20.0 mm
EO-1622	20.0 cm	8"	25.0 mm
EO-1623	25.0 cm	10"	25.0 mm

Ribbon Retractor



REF #	SIZE cm	SIZE in	SHAPE
EO-1624	33.0 cm	13"	20.0 mm
EO-1625	33.0 cm	13"	25.0 mm
EO-1626	33.0 cm	13"	32.0 mm
EO-1627	33.0 cm	13"	40.0 mm
EO-1628	33.0 cm	13"	45.0 mm
EO-1629	33.0 cm	13"	50.0 mm
EO-1630	33.0 cm	13"	65.0 mm
EO-1631	33.0 cm	13"	76.0 mm

Ribbon Retractor



REF #	SIZE cm	SIZE in
EO-1632	03.0 cm	1 1/4"

Standard Fat Spreaders, self-retaining



REF #	SIZE cm	SIZE in
EO-1633	04.0 cm	1 1/2"

Standard Fat Spreaders, self-retaining



REF #	SIZE cm	SIZE in	SHAPE
EO-1634	06.0 cm	2 1/4"	Fig.1

Fig 1  
3x3 teeth sharp

Buckley Wound Spreaders, self-retaining



REF #	SIZE cm	SIZE in	SHAPE
EO-1635	07.0 cm	2 3/4"	Fig.1
EO-1636	10.0 cm	4"	Fig.2
EO-1637	07.0 cm	2 3/4"	Fig.3
EO-1638	10.0 cm	4"	Fig.4

Fig 1  
4x4 teeth sharp

Fig.2  
4x4 teeth sharp

Fig.3  
4x4 teeth blunt

Fig.4  
4x4 teeth blunt

Alm Wound Spreaders, self-retaining



**GENERAL INSTRUMENTS**  
**SELF RETRAINING RETRACTORS**  
 Wound Spreader, Fat Spreader



REF #	SIZE cm	SIZE in	SHAPE
EO-1639	05.0 cm	2"	Fig.1
EO-1640	05.0 cm	2"	Fig.2
EO-1641	05.0 cm	2"	Fig.3
EO-1642	05.0 cm	2"	Fig.4

Fig.1	Fig.2
2x3 teeth sharp	2x3 teeth blunt
Fig.3	Fig.4
3x4 teeth sharp	3x4 teeth blunt

**Finsen**  
 Wound Spreaders, self-retaining



REF #	SIZE cm	SIZE in	SHAPE
EO-1643	07.0 cm	2 3/4"	Fig.1
EO-1644	07.0 cm	2 3/4"	Fig.2

Fig.1	Fig.2
3x4 teeth sharp	3x4 teeth blunt

with adjustable screw

**Standard**  
 Wound Spreaders, self-retaining



REF #	SIZE cm	SIZE in	SHAPE
EO-1645	04.0 cm	1 1/2"	Fig.1

Fig.1
3x3 teeth sharp

**Logan**  
 Wound Spreaders, self-retaining

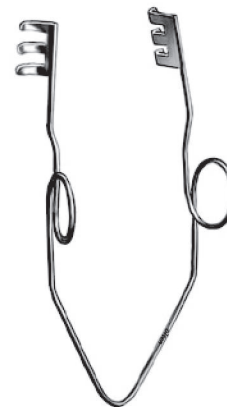

REF #	SIZE cm	SIZE in
EO-1646	05.5 cm	2 1/4"

**Standard**  
 Fat Spreaders, self-retaining



REF #	SIZE cm	SIZE in	SHAPE
EO-1647	10.0 cm	4"	Fig.1

Fig.1
4x4 teeth blunt

**Standard**  
 Wound Spreaders, self-retaining



REF #	SIZE cm	SIZE in	SHAPE
EO-1648	10.0 cm	4"	Fig.1

Fig.1
3x3 teeth blunt

**Jansen**  
 Wound Spreaders, self-retaining



**GENERAL INSTRUMENTS**  
**SELF RETRAINING RETRACTORS**  
**Wound Spreader**



**Scalp-Contour**  
 Wound Spreaders, self-retaining

REF #	SIZE cm	SIZE in	SHAPE
EO-1649	13.5 cm	5 1/4"	Fig.1
EO-1650	13.5 cm	5 1/4"	Fig.2

Fig.1  
3x4 teeth sharp

Fig.2  
3x4 teeth blunt



**Anderson-Adson**  
 Wound Spreaders, self-retaining

REF #	SIZE cm	SIZE in	SHAPE
EO-1651	20.0 cm	8"	Fig.1

Fig.1  
4x4 teeth sharp



**Adson**  
 Wound Spreaders, self-retaining

REF #	SIZE cm	SIZE in	SHAPE
EO-1652	26.0 cm	10 1/4"	Fig.1
EO-1653	26.0 cm	10 1/4"	Fig.2
EO-1654	29.0 cm	11 1/2"	Fig.3
EO-1655	29.0 cm	11 1/2"	Fig.4

Fig.1  
3x4 teeth sharp

Fig.2  
3x4 teeth blunt

Fig.3  
6x6 teeth sharp

Fig.4  
6x6 teeth blunt



**Weitlaner**  
 Wound Spreaders, self-retaining

REF #	SIZE cm	SIZE in	SHAPE
EO-1656	11.0 cm	4 1/4"	Fig.1
EO-1657	11.0 cm	4 1/4"	Fig.2

Fig.1  
2x3 teeth sharp

Fig.2  
2x3 teeth blunt



**Weitlaner-Wullstein**  
 Wound Spreaders, self-retaining

REF #	SIZE cm	SIZE in	SHAPE
EO-1658	13.0 cm	5"	Fig.1
EO-1659	13.0 cm	5"	Fig.2

Fig.1  
3x3 teeth sharp

Fig.2  
3x3 teeth blunt



**Mollison**  
 Wound Spreaders, self-retaining

REF #	SIZE cm	SIZE in	SHAPE
EO-1660	15.5 cm	6"	Fig.1

Fig.1  
4x4 teeth sharp



**GENERAL INSTRUMENTS**  
**SELF RETRAINING RETRACTORS**  
**Wound Spreader**



REF #	SIZE cm	SIZE in	SHAPE
EO-1661	20.0 cm	8"	Fig.1
EO-1662	20.0 cm	8"	Fig.2

Fig.1  
3x4 teeth  
sharp

Fig.2  
3x4 teeth  
blunt

**Weitlaner**  
Wound Spreaders, self-retaining

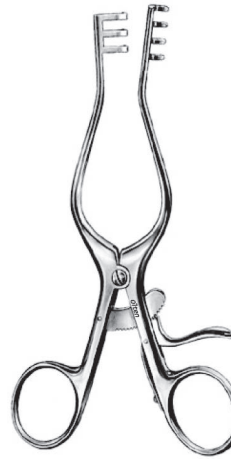

REF #	SIZE cm	SIZE in	SHAPE
EO-1663	13.5 cm	5 1/4"	Fig.1
EO-1664	13.5 cm	5 1/4"	Fig.2
EO-1665	16.0 cm	6 1/4"	Fig.3
EO-1666	16.0 cm	6 1/4"	Fig.4

Fig.1  
3x4 teeth  
sharp

Fig.2  
3x4 teeth  
blunt

Fig.3  
3x4 teeth  
sharp

Fig.4  
3x4 teeth  
blunt

**Weitlaner**  
Wound Spreaders, self-retaining



REF #	SIZE cm	SIZE in	SHAPE
EO-1667	13.0 cm	5"	Fig.1
EO-1668	13.0 cm	5"	Fig.2

Fig.1  
2x2 teeth  
sharp

Fig.2  
2x2 teeth  
blunt

**Plester**  
Wound Spreaders, self-retaining



REF #	SIZE cm	SIZE in	SHAPE
EO-1669	10.5 cm	4"	Left / blunt

**Plester**  
Wound Spreaders, self-retaining



REF #	SIZE cm	SIZE in	SHAPE
EO-1670	10.5 cm	4"	Right / blunt

**Plester**  
Wound Spreaders, self-retaining



REF #	SIZE cm	SIZE in	SHAPE
EO-1671	13.5 cm	5 1/4"	Fig.1

Fig.1  
3x3 teeth  
blunt

**Milligan**  
Wound Spreaders, self-retaining



**GENERAL INSTRUMENTS**  
**SELF RETRAINING RETRACTORS**  
 Wound Spreader, Central Blade



REF #	SIZE cm	SIZE in	SHAPE
EO-1672	16.0 cm	6 1/4"	Fig.1

Fig.1  
 2x3 teeth  
 sharp

complete  
 with 3 central blades

EO-1673
EO-1674
EO-1675

Henley  
 Wound Spreaders, self-retaining



REF #	SHAPE
EO-1673	Fig.1
EO-1674	Fig.2
EO-1675	Fig.3

Fig.1      Fig.2  
 16x19 mm    16x25 mm

Fig.3  
 16x32 mm

Henley  
 Central blades



REF #	SIZE cm	SIZE in
EO-1676	13.5 cm	5 1/4"

Weitlaner, Baby  
 Wound Spreaders, self-retaining



REF #	SIZE cm	SIZE in	SHAPE
EO-1677	13.5 cm	5 1/4"	Fig.1
EO-1678	16.5 cm	6 1/2"	Fig.2
EO-1679	21.0 cm	8 1/4"	Fig.3
EO-1680	24.5 cm	9 3/4"	Fig.4

Fig.1  
 3x4 teeth  
 sharp

Fig.3  
 3x4 teeth  
 sharp

Fig.2  
 3x4 teeth  
 sharp

Fig.4  
 3x4 teeth  
 sharp

Adson  
 Wound Spreaders, self-retaining



REF #	SIZE cm	SIZE in	SHAPE
EO-1681	13.5 cm	5 1/4"	Fig.1
EO-1682	16.5 cm	6 1/2"	Fig.2
EO-1683	21.0 cm	8 1/4"	Fig.3
EO-1684	24.5 cm	9 3/4"	Fig.4

Fig.1  
 3x4 teeth  
 blunt

Fig.3  
 3x4 teeth  
 blunt

Fig.2  
 3x4 teeth  
 blunt

Fig.4  
 3x4 teeth  
 blunt

Adson  
 Wound Spreaders, self-retaining



REF #	SIZE cm	SIZE in	SHAPE
EO-1685	16.5 cm	6 1/2"	Fig.1
EO-1685-1	16.5 cm	6 1/2"	Fig.2
EO-1686	32.0 cm	12 1/2"	Fig.1
EO-1686-1	32.0 cm	12 1/2"	Fig.2

Fig.1  
 4x4 teeth  
 sharp

Fig.2  
 4x4 teeth  
 blunt

Beckmann  
 Wound Spreaders, self-retaining



**GENERAL INSTRUMENTS**  
**SELF RETRAINING RETRACTORS**  
 Wound Spreader, Blade



REF #	SIZE cm	SIZE in
EO-1687	25.0 cm	9¾"

complete with each pair  
 EO-1688  
 EO-1689  
 EO-1690  
 EO-1691  
 EO-1692

**Cloward**  
 Wound Spreaders, self-retaining



REF #	SIZE mm
EO-1688	40 mm
EO-1689	45 mm
EO-1690	50 mm
EO-1691	55 mm
EO-1692	60 mm

**Cloward (Spare Blade)**



REF #	SIZE cm	SIZE in
EO-1693	15.0 cm	6"

complete with each pair  
 EO-1694  
 EO-1695  
 EO-1696  
 EO-1697  
 EO-1698

**Cloward**  
 Wound Spreaders, self-retaining



REF #	SIZE mm
EO-1694	40 mm
EO-1695	45 mm
EO-1696	50 mm
EO-1697	55 mm
EO-1698	60 mm

**Cloward (Spare Blade)**



REF #	SIZE cm	SIZE in	SHAPE
EO-1699	30.5 cm	12"	Fig.1
EO-1700	30.5 cm	12"	Fig.2

Fig.1  
 4x4 teeth sharp

Fig.2  
 4x4 teeth blunt

**Beckman-Adson**  
 Wound Spreaders, self-retaining



REF #	SIZE cm	SIZE in	SHAPE
EO-1701	32.0 cm	12½"	Fig.1

Fig.1  
 7x7 teeth sharp

**Beckman-Eaton**  
 Wound Spreaders, self-retaining

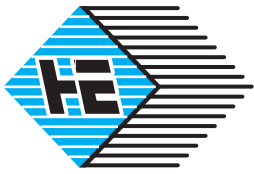

**GENERAL INSTRUMENTS**  
**SELF RETRAINING RETRACTORS**  
 Wound Spreader, Abdominal Retractor



REF #    SIZE cm    SIZE in    SHAPE  
 EO-1702    33.0 cm    13"    Fig.1

Fig.1  
 4x5 teeth  
 blunt

**Adson**  
 Wound Spreaders, self-retaining



REF #    SIZE cm    SIZE in    SHAPE  
 EO-1703    28.5 cm    11¼"    Fig.1  
 EO-1704    28.5 cm    11¼"    Fig.2

Fig.1  
 6x6 teeth  
 left

Fig.2  
 6x6 teeth  
 right

**Standard**  
 Wound Spreaders, self-retaining



REF #    SIZE cm    SIZE in  
 EO-1705    18.0 cm    7"

**Gelpi**  
 Wound Spreaders, self-retaining



REF #    SIZE cm    SIZE in  
 EO-1706    13.0 cm    5"

**Gelpi**  
 Wound Spreaders, self-retaining



REF #    SIZE cm    SIZE in  
 EO-1707    18.5 cm    7¼"

**Gelpi**  
 Wound Spreaders, self-retaining



REF #    SIZE cm    SIZE in  
 EO-1708    20.0 cm    8"

complete with  
 2 pairs of lateral blades  
 18x40 mm  
 27x40 mm

OPENING  
 < 80 mm >

**Collin, Baby**  
 Abdominal Retractor



## GENERAL INSTRUMENTS

SELF RETRAINING RETRACTORS  
Wound Spreader, Thyroid & Vaginal Retractor,  
Abdominal Retractor

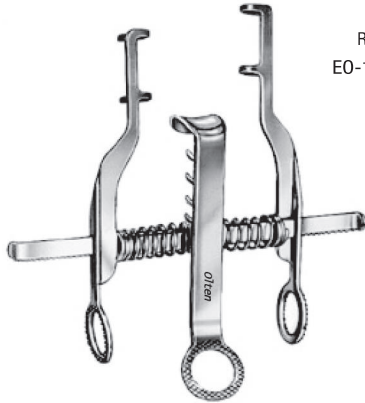

REF # SIZE cm SIZE in SHAPE  
EO-1709 07.5 cm 3" Fig.1

Fig.1  
complete with  
central blade  
10x18 mm

Vickers Low-Profile  
Wound Spreaders, self-retaining



REF # SIZE cm SIZE in SHAPE  
EO-1710 09.0 cm 3½" Fig.1

Fig.1  
complete with  
central blade  
10x18 mm

Vickers Low-Profile  
Wound Spreaders, self-retaining



REF # SIZE cm SIZE in SHAPE  
EO-1711 07.5 cm 3" Fig.1

Fig.1  
complete with  
central blade  
10x18 mm

Vickers Low-Profile  
Wound Spreaders, self-retaining



REF # SIZE cm SIZE in SHAPE  
EO-1712 05.0 cm 2" Fig.1

Fig.1  
blunt  
ring model  
for thumb & fingers

Vickers  
Wound Spreaders, self-retaining



REF # SIZE cm SIZE in  
EO-1713 15.5 cm 6"

Joll  
Thyroid and Vaginal retractor



REF # SIZE cm SIZE in  
EO-1714 24.0 cm 9¼"

complete with  
1 pair of lateral blades  
38x60 mm

Collin  
Abdominal Retractor

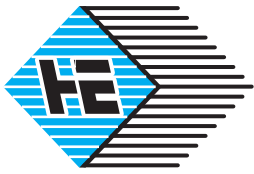

**GENERAL INSTRUMENTS**  
**SELF RETRAINING RETRACTORS**  
 Abdominal Retractor, Lateral Blade



REF #	SIZE cm	SIZE in	SHAPE
EO-1715	22.5 cm	9"	Fig. 1
EO-1716	22.5 cm	9"	Fig. 2

Fig.1  
 complete with  
 1 pair of lateral blades  
 38x60 mm  
 and central blade  
 38x55 mm

Fig.2  
 complete with  
 1 pair of lateral blades  
 40x80 mm  
 and central blade  
 50x75 mm

**Collin**  
 Abdominal Retractor



REF #	SIZE cm	SIZE in
EO-1717	31.0 cm	12 1/4"

complete with  
 1 pair of lateral blades  
 60x80 mm  
 and central blade  
 60x75 mm

**Collin**  
 Abdominal Retractor

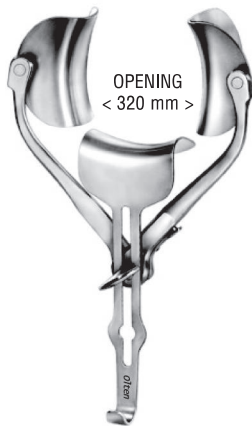

REF #	SIZE cm	SIZE in	SHAPE
EO-1718	28.0 cm	11"	Fig. 1
EO-1719	30.0 cm	12"	Fig. 2

Fig.1  
 complete with  
 1 pair of lateral blades  
 50x58 mm  
 and central blade  
 55x70 mm

Fig.2  
 complete with  
 1 pair of lateral blades  
 60x80 mm  
 and central blade  
 80x90 mm

**Ricard**  
 Abdominal Retractor



REF #	SIZE mm
EO-1720	18x40 mm
EO-1721	27x40 mm
EO-1722	38x60 mm
EO-1723	40x80 mm
EO-1724	45x80 mm
EO-1725	60x80 mm

**Standard**  
 Lateral Blade



**Standard**  
 Lateral Blade

REF #	SIZE mm
EO-1726	50x70 mm
EO-1727	52x110mm
EO-1728	70x55 mm
EO-1729	75x90 mm
EO-1730	50x58 mm
EO-1731	60x80 mm
EO-1732	72x85 mm

REF #	SIZE cm	SIZE in
EO-1733	12.5 cm	5"

lateral blades  
 40x30 mm



**Gosset-Baby**  
 Abdominal Retractor



**GENERAL INSTRUMENTS**  
**SELF RETRAINING RETRACTORS**  
**Abdominal Retractor**



OPENING  
 < 160 mm >

REF # SIZE cm SIZE in  
 EO-1734 16.0 cm 6 1/4"

lateral blades  
 63x35 mm  
 central blade  
 60x56 mm

**Gosset**  
 Abdominal Retractor

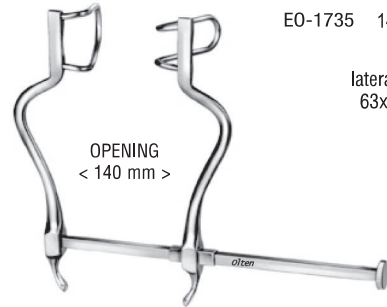

OPENING  
 < 140 mm >

REF # SIZE cm SIZE in  
 EO-1735 14.0 cm 5 1/2"

lateral blades  
 63x35 mm

**Gosset**  
 Abdominal Retractor

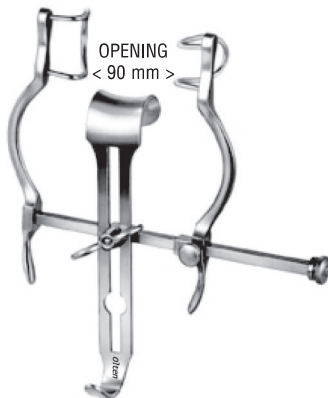

OPENING  
 < 90 mm >

REF # SIZE cm SIZE in  
 EO-1736 9.0 cm 3 1/2"

lateral blades  
 27x28 mm  
 central blade  
 24x20 mm

**Balfour-Baby**  
 Abdominal Retractor

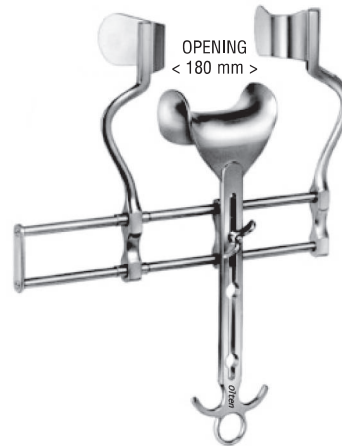

OPENING  
 < 180 mm >

REF # SIZE cm SIZE in  
 EO-1737 18.0 cm 7"

lateral blades  
 70x35 mm  
 central blade  
 45x80 mm

**Balfour**  
 Abdominal Retractor

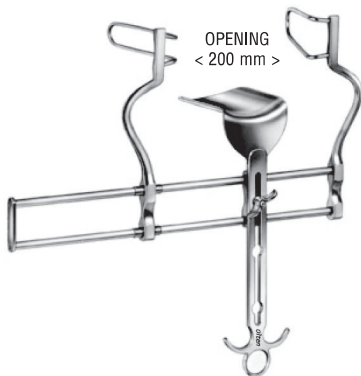

OPENING  
 < 200 mm >

REF # SIZE cm SIZE in  
 EO-1738 20.0 cm 8"

lateral blades  
 100x35 mm  
 central blade  
 100x60 mm

**Balfour**  
 Abdominal Retractor



REF #	SIZE in	Central Blade
EO-1739	7"	(45 x 80) mm
EO-1739-1	8"	(45 x 80) mm
EO-1739-2	10"	(70 x 85) mm

**Balfour**  
 Abdominal Retractor  
 Interchangeable Blade

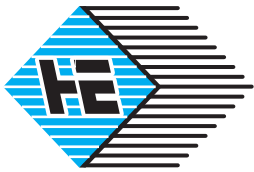

**GENERAL INSTRUMENTS**  
**SELF RETRAINING RETRACTORS**  
**Abdominal Retractor, Central Blade**

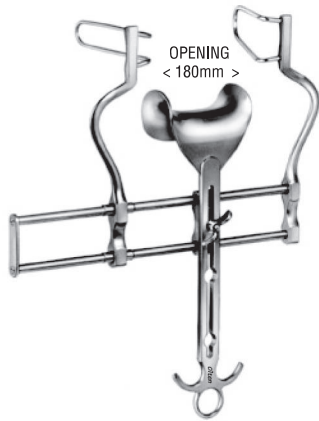

OPENING  
 < 180mm >

REF # SIZE cm SIZE in  
 EO-1740 18.0 cm 7"

lateral blades  
 70x35 mm

central blade  
 45x80 mm

**Balfour**  
 Abdominal Retractor

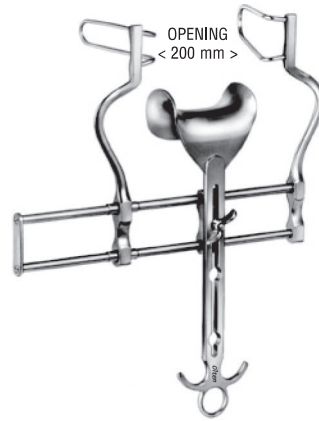

OPENING  
 < 200 mm >

REF # SIZE cm SIZE in  
 EO-1741 20.0 cm 8"

lateral blades  
 70x35 mm

central blade  
 45x80 mm

**Balfour**  
 Abdominal Retractor



OPENING  
 < 250 mm >

REF # SIZE cm SIZE in  
 EO-1742 25.0 cm 10"

lateral blades  
 100x35 mm  
 central blade  
 70x85 mm

**Balfour**  
 Abdominal Retractor



REF # SIZE mm  
 EO-1743 45x80 mm  
 EO-1744 70x85 mm

**Balfour**  
 Central Blade



REF #  
 EO-1745  
 complete with  
 2 fixed lateral blades,  
 1 blade 110x70 mm  
 and 2 blades  
 80x45 mm

**O'Sullivan-O'Connor**  
 Abdominal Retractor